

Instruction Manual

Bed Frame For Full Mattress

Model BOAT-17

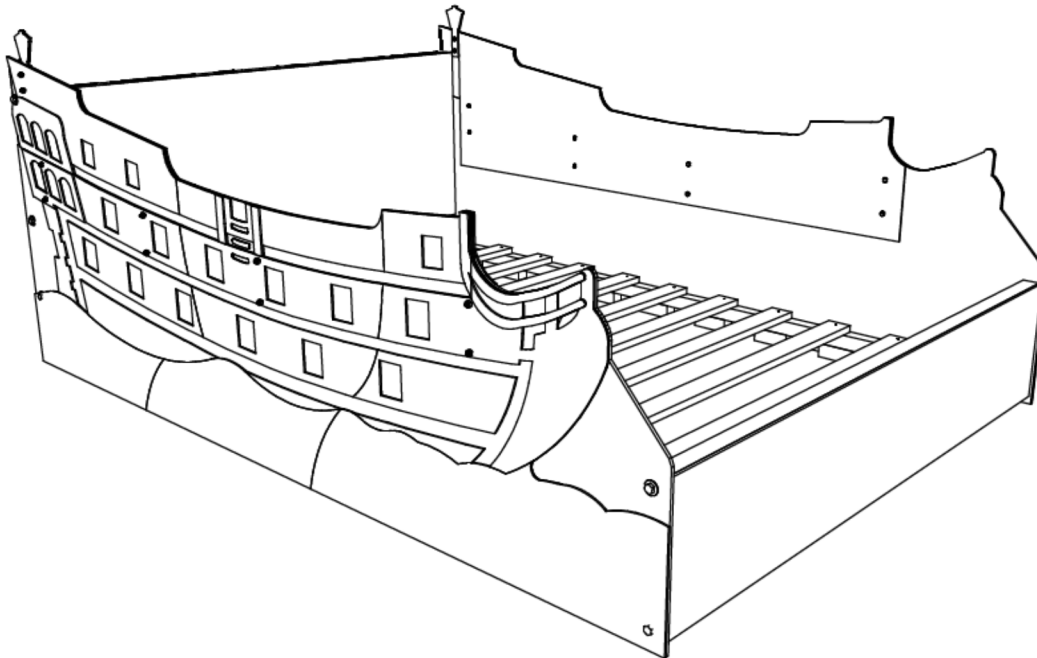

Read all instructions before assembly and use.
Keep instructions for future use.



ADULT ASSEMBLY REQUIRED

Due to the presence of small parts during assembly, keep out of reach of children until assembly is complete.



1900 Alfa Drive
Lancaster, PA 17601
(717) 269-8934
tradecraftspecialties@gmail.com
www.tradecraftspecialties.com

Use and Warnings

Your child's safety is our top priority. Please observe the following safety warnings to ensure the safe use of this product:

- Weight limitation: minimum weight requirement for this bed is 50 lbs. This product is not to be used by any occupant under 50 lbs. Do not let any child under 50 lbs. play or sleep on or around the bed. Maximum weight is 350 lbs.
- Do not stand or sit on shelf.
- Do not stand, sit, or otherwise occupy or apply weight to bed slats until a mattress or box spring has been installed. The slats are not rated or tested for individual loads without the application of mattress or box spring.
- Do not allow jumping or horseplay on the bed.
- Do not use bed if any parts are missing or damaged.
- Do not use substitute parts. Contact manufacturer should replacement parts be necessary.
- Do not use a water or sleep flotation mattress.
- Before assembly and use, inspect bed for damaged hardware, loose joints, missing pieces or sharp edges.
- Warning: hardware included with this product may have sharp points or edges. Assembly by an adult is required. Keep all loose hardware out of reach of children.
- Warning: small parts are a choking hazard for children. Make sure that all hardware is properly and tightly installed to prevent access to loose parts by children. Properly discard excess hardware after assembly to prevent access of loose parts to children. Properly discard all packing materials.
- Always make sure the mattress is firmly seated against the headboard. Excess space may result in entrapment which may lead to serious injury or death.
- Mattress size: This bed is intended for use only with a standard Full mattress 74" - 75" long by 51 1/2" - 52 1/2" wide (mattress not included). Use of an incorrectly sized mattress may leave space between the edge of the mattress and the edge of the bed. Excess space may result in entrapment which may lead to serious injury or death.
- Warning: Linseed oil is used to create a smooth final surface on some materials. Although rare, it is possible to have an allergy to linseed oil (just like peanut and soy oils). This may cause a runny nose, sneezing, or in rare cases more fatal effects which can result in difficulty breathing or death. Please verify that you or your child does not have an allergy to linseed oil before using this product.

General Specifications

Assembled dimensions (approximate): 81.5" long, 58" wide, 35" high.

Care and Maintenance

- Check all fasteners periodically for tightness.
- Clean the surface using a slightly damp cloth if necessary. Do not use any corrosive cleaning products or abrasives that may degrade or damage the surface. Furniture polish may be used to clean dust off the surface.
- We recommend that any cleaning materials first be tested on a surface that would not be visible during the course of normal use.
- Lift slightly when moving on carpet or rough surface to avoid bending or damaging the supporting structure of the bed.
- Use of a vaporizer close to bed may cause the surface to swell and the surface to peel.
- Check the mattress periodically and when changing sheets to ensure mattress is tight against headboard.

Assembly Notes

Hardware notes: do not fully tighten any fasteners until all hardware is in place. Failure to follow these instructions may cause fasteners to misalign during assembly. If using power tools to aid in assembly, use caution. Power tools may over-tighten fasteners and split or damage the material.

Tools required (not included):

Phillips head screw driver

7/16" wrench or adjustable wrench





Important Information

Each one of our beds is handmade, hand painted, and hand packaged. Minor imperfections may occur that are not manufacturing defects, but rather a result of the handcrafting process that makes our beds unique and special.

After unpacking, this product may have an associated smell for several days. This smell is merely a result of the natural linseed oils and/or other products used in the preparation and manufacturing of the material, and does not contain harmful products. The smell should completely dissipate within several days. The smell may be stronger on products with areas of exposed unpainted material.

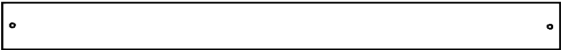
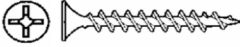
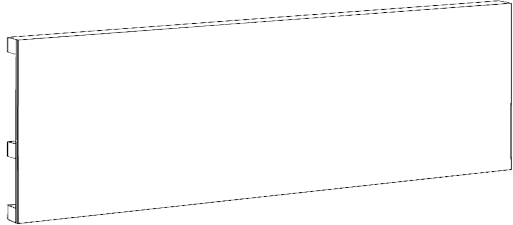
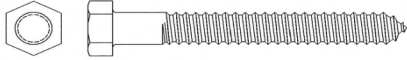
Disassembly

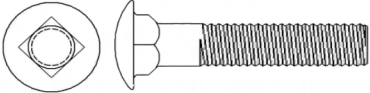
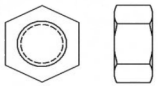
Parts List

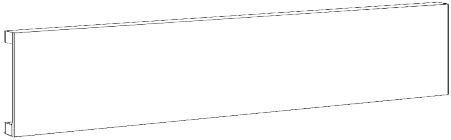
Part #:	Quantity:	Description:	Reference image only (not to scale):
[A]	(2)	Side assembly	(appearance varies by model)
[B]	(11)	Mattress support bar	
[C]	(22)	Screw – mattress support bar	
[D]	(1)	Headboard	
[E]	(10)	1/4" Lag bolt	
[F]	(10)	1/4" Metal flat washer	
[J]	(20)	1/4" Carriage head bolt	
[K]	(20)	1/4" Nut	
[L]	(20)	1/4" Metal flat washer	
[A2]	(2)	Auxiliary side assembly	(appearance varies by model)
[M]	(1)	Footboard	
[A3]	(2)	Auxiliary side panel	(appearance varies by model)

Assembly Steps

Step 1: Ensure there is enough room to lay out all parts. Carefully unpack all parts and hardware and check that everything is present and undamaged. It is helpful to have more than one person available for assembly.

Step 2: Loosely fasten side assemblies [A] to headboard [D] and footboard [M] using lag bolts [E] and flat washers [F], (4) lag bolts per side with a washer on each lag bolt. **Do not yet fully tighten lag bolts.**

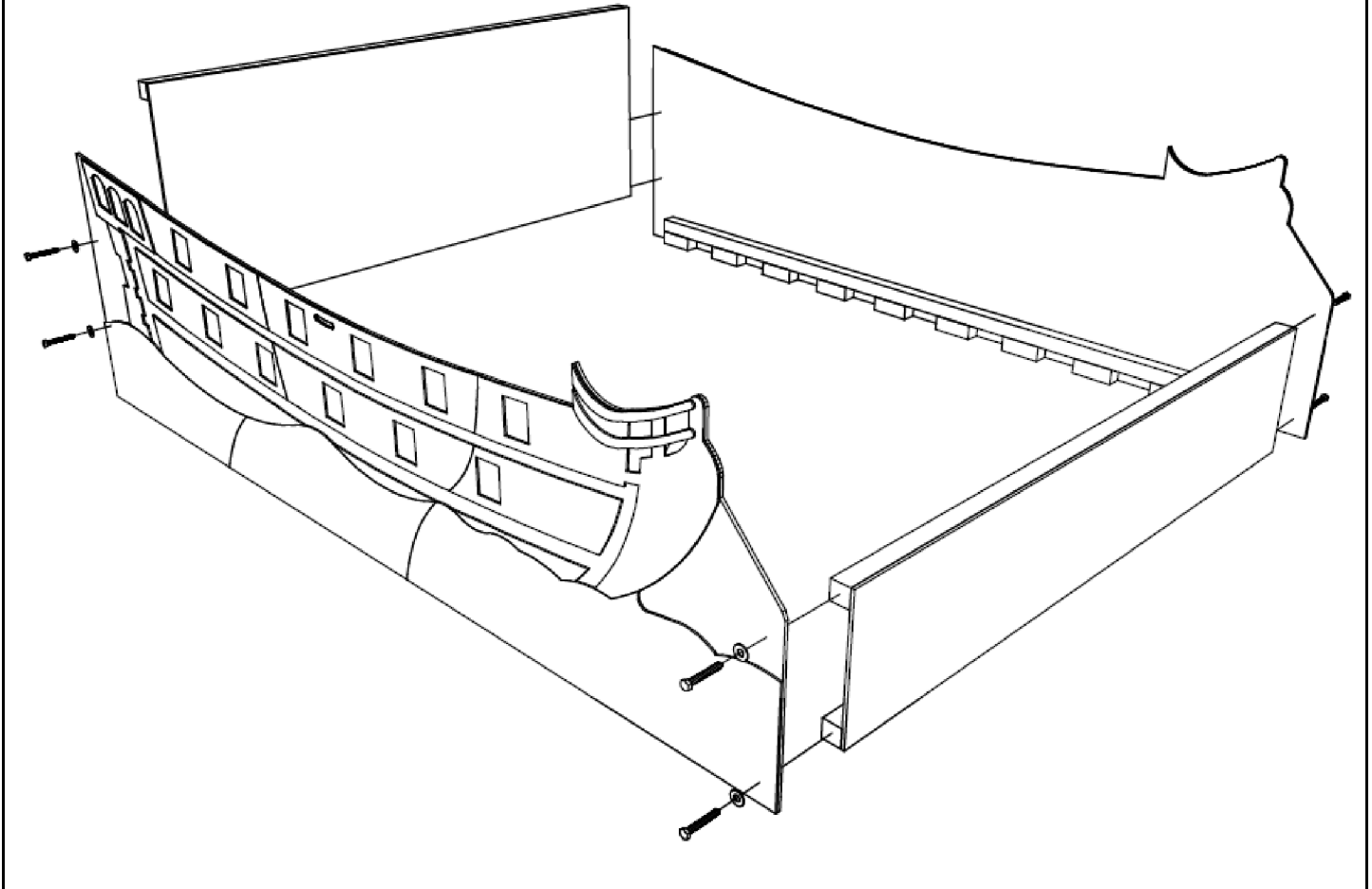

Step 2 - A: Loosely fasten auxiliary side panels [A3] to side panels [A] using carriage bolts [J], nuts [K] and flat washers [L], (8) bolts per side with a washer and nut on each nut. Bolts shall face outward so that the smooth head is in.

Loosely fasten side assemblies to headboard top bar using lag bolts [E] and flat washers [F], (1) lag bolt per side with a washer on each lag bolt. **Do not yet fully tighten lag bolts.**

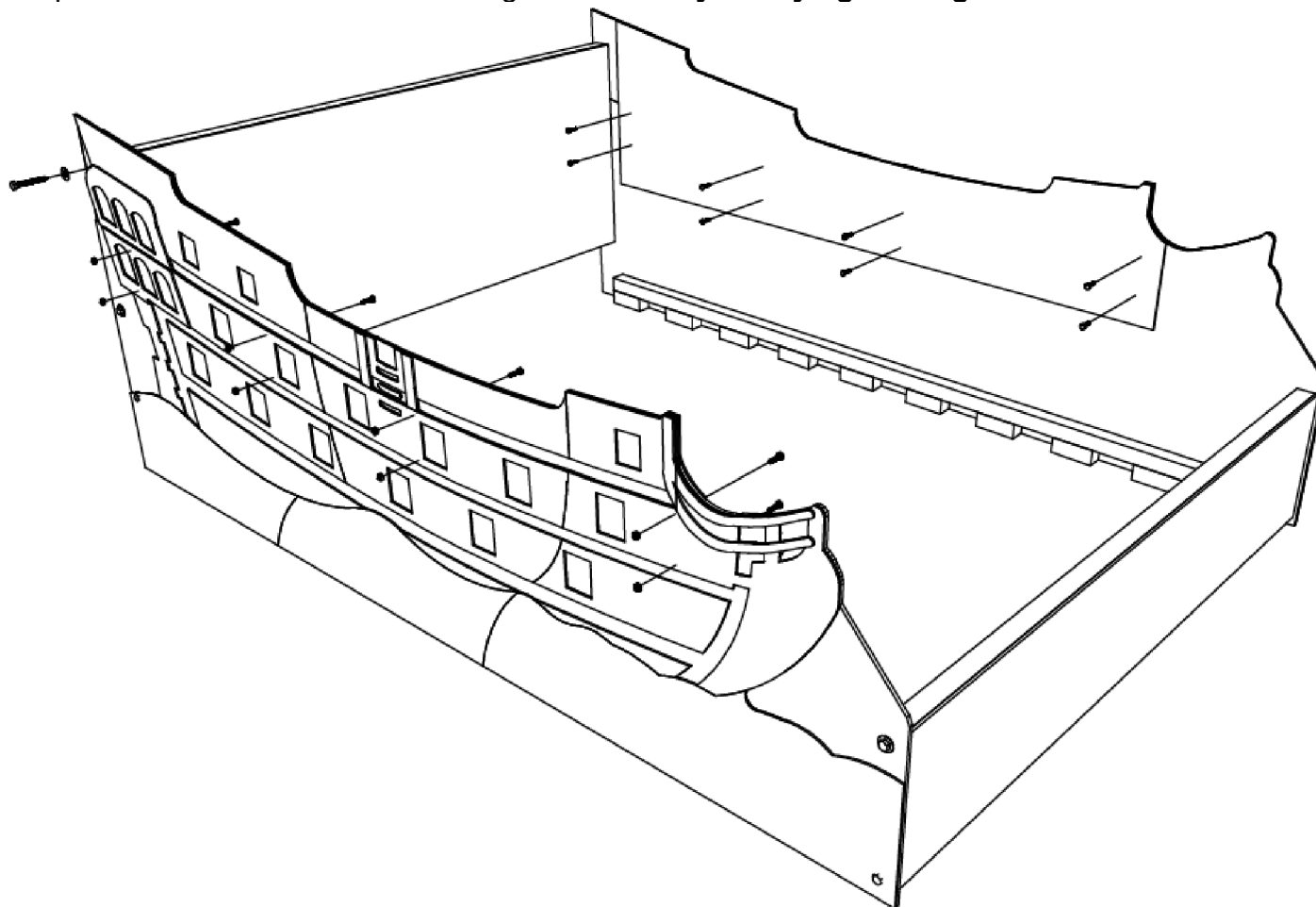

Step 3: Fasten mattress support bars [B] to support rail of side assemblies [A] using screws [C]. Use (1) screw at each end of support bar. Make sure support bar end is tight and perpendicular with side of bed. Start at rear of bed and work towards front. Leave 4.5" gaps between each support bar (approximately 7" center-to-center).

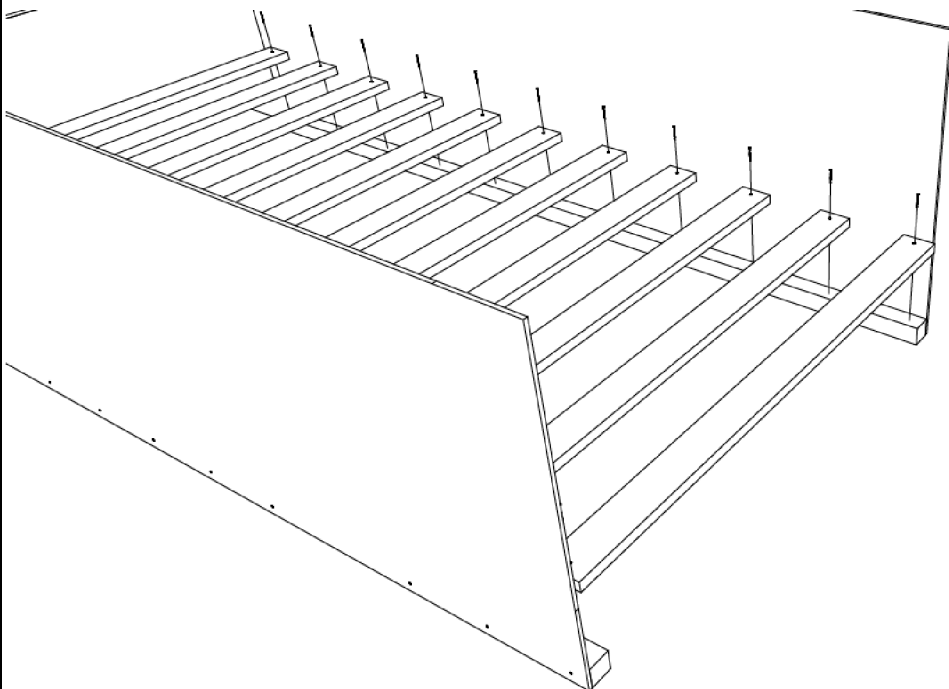

Step 3 - I: Fasten auxiliary side assemblies [A2] to side assemblies [A] using bolts [J] and nuts [K]. Use (1) washer [L] on each nut. Bolts shall face outward so that the smooth head is in. Side assemblies pictured are for reference only; individual assembly types will vary with bed model. For exact fit and style, refer to picture on cover of manual.

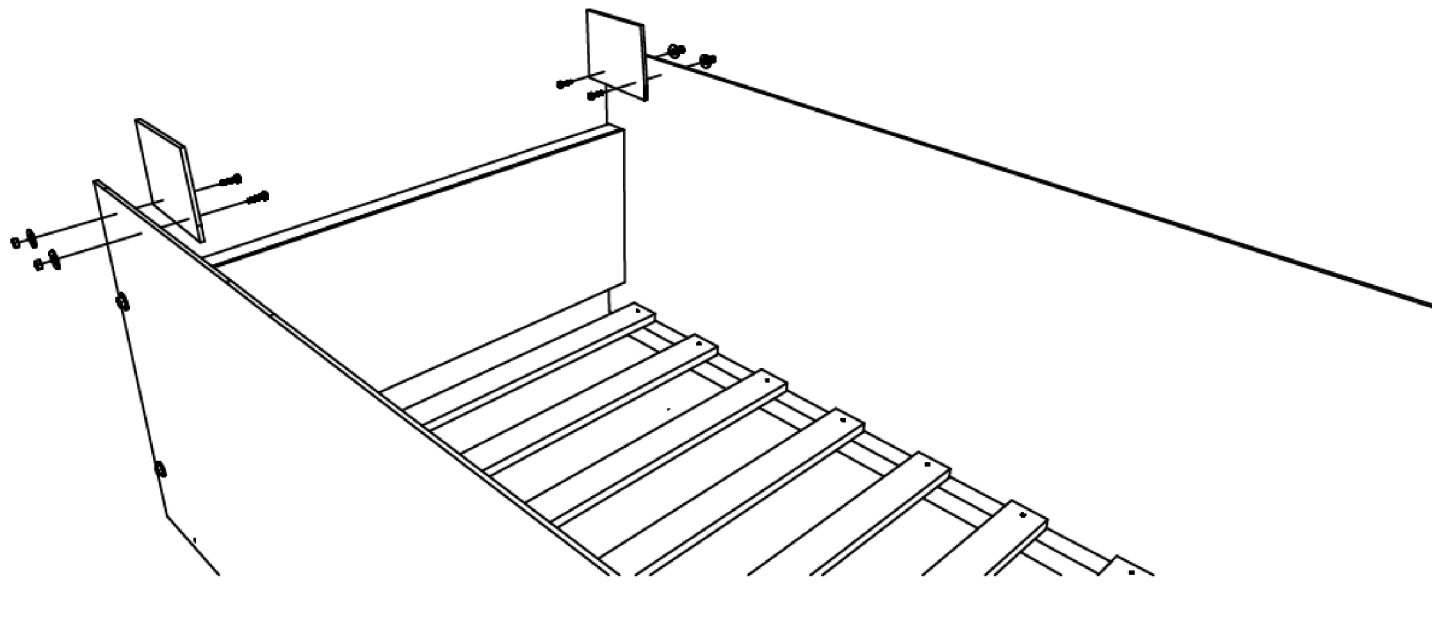

Step 4: Tighten all hardware. Make sure all assembled parts are tight and secure.