

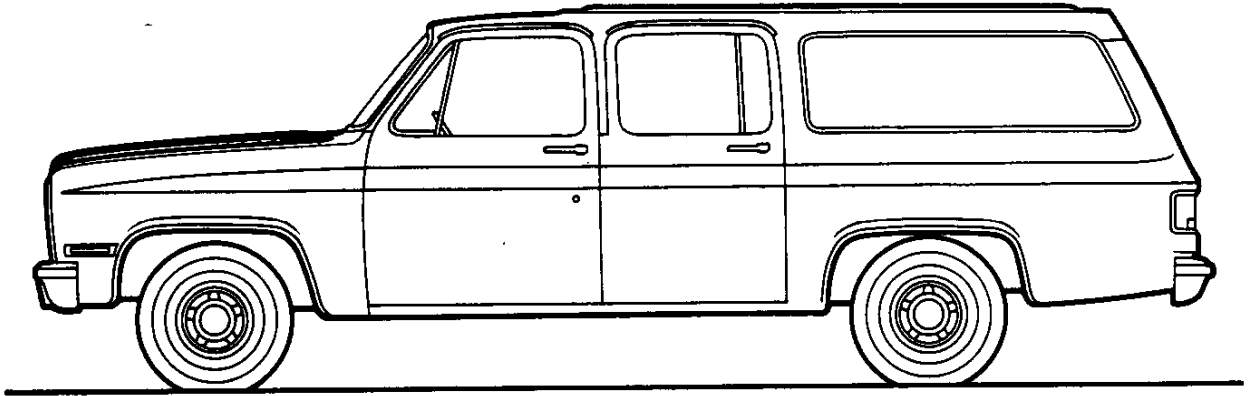

C/K SUBURBAN

SUBURBAN MODEL SELECTOR



SERIES	MODEL NUMBER	BODY ORDERING CODE			
		GASOLINE MODELS		DIESEL MODELS	
		PANEL REAR DOORS	TAILGATE	PANEL REAR DOORS	TAILGATE
C10/1500	C10906	ZW9	E55	ZW9/B3J	E55/B3J
C20/2500	C20906	ZW9	E55	ZW9/B3J	E55/B3J
K10/1500 (4X4)	K10906	ZW9	E55	ZW9/B3J	E55/B3J
K20/2500 (4X4)	K20906	ZW9	E55	ZW9/B3J	E55/B3J

GASOLINE

C/K SUBURBAN—2-Wheel Drive

STANDARD SPECIFICATIONS

(See Gray Tab Section for Specification Details)

Series	C10/1500	C20/2500
Engine	5.0 Liter, 305 4-bbl V8	
Base Equip.	5.7 Liter, 350 4-bbl. V8 12", 150 sq. in.	
Clutch	—	
Air Filter	Oiled-paper Element	
Oil Filter	Throwaway Type	
Exhaust System	*Single; Aluminized	
Emission Control Systems	See Engine & Cooling Section for specific model applications	
Suspension, Front	Independent; Coil Springs	
Capacity	3250 lb.	3800 lb.
Springs @ Ground	1625 lb. ea.	1900 lb. ea.
Shock Absorbers	25mm dia.	32mm dia.
Stabilizer Bar	—	1.06" dia.
Suspension, Rear	Salisbury Axle; Hypoid Drive; Two-stage Multi-leaf Springs	
Axle Capacity	4000 lb.	6000 lb.
Axle Ratio	3.08	3.42
Springs @ Ground	2000 lb. ea.	3000 lb. ea.
Shock Absorbers	25mm dia.	32mm dia.
Brakes	Hydraulic; Self-adjusting	
Front	Disc; 11.86" Rotor	Disc; 12.5" Rotor
Rear	Drum; 11.15" x 2.75"	Drum; 13.0" x 2.5"
Booster	Dual Diaphragm	
Parking	Cable to Rear Wheels	
Electrical	12 Volt; Negative Ground	
Battery—Freedom Type	405 CCA♦ @ 0°F.	
—Reserve Capacity	75 min. @ 80°F.	
Delcotron Generator	37 amp.	
Frame	Carbon Steel; 36,39,000 psi	
Section Modulus	3.10	3.88
Fuel Tank (nominal capacity)	25 gal.	
Steering Gear Type	Manual; Recirculating Ball Gear	
Linkage	Parallelogram	
Transmission	4-Speed Automatic w/Overdrive	4-Speed Manual
Shift Location	Steering Column	Floor
Tires	(5) P235/75R15 All Seasons Steel Belted Radial	Fr. (2) LT235/85R16D (8PR) Rr. (2) LT235/85R16E (10PR)
Wheels	(5) Disc 15" x 6"	(4) Disc 16" x 6.5"

■Standard engine not available for registration in the State of California; see Power Teams chart.

*Dual tail pipe on C10/1500 model.

♦CCA-Cold Cranking Amps

C/K SUBURBAN—2-Wheel Drive

DIESEL

STANDARD SPECIFICATIONS

(See Gray Tab Section for Specification Details)

Series	C10/1500	C20/2500
Engine	6.2 Liter, 379 Cu. In. V8 Diesel	
Base Equip.	Poly-wrapped, Oiled-paper Element	
Air Filter	Throwaway Type	
Oil Filter	Standard	
Oil Cooler	Dual; Aluminized	
Exhaust System	See Engine & Cooling Section for specific model applications	
Emission Control Systems		
Suspension, Front	Independent; Coil Springs	
Capacity	3400 lb.	3800 lb.
Springs @ Ground	1700 lb. ea.	1900 lb. ea.
Shock Absorbers	25mm dia.	32mm dia.
Stabilizer Bar	1.06" dia.	
Suspension, Rear	Salisbury Axle; Hypoid Drive; Two-stage Multi-leaf Springs	
Axle Capacity	4000 lb.	6000 lb.
Axle Ratio	3.08	3.73
Springs @ Ground	2000 lb. ea.	3000 lb. ea.
Shock Absorbers	25mm dia.	32mm dia.
Brakes	Hydraulic; Self-adjusting	
Front	Disc; 11.86" Rotor	Disc; 12.5" Rotor
Rear	Drum; 11.15" x 2.75"	Drum; 13.0" x 2.5"
Booster	Hydraulic Power	
Parking	Cable to Rear Wheels	
Electrical	12 Volt; Negative Ground	
Battery—Freedom Type	Two; 500 CCA♦ ea. @ 0°F.	
—Reserve Capacity	115 min. ea. @ 80°F.	
Delcotron Generator	66 amp.	
Engine Block Heater	600 watts, 120 volts	
Frame	Carbon Steel; 36,39,000 psi	
Section Modulus	3.10	3.88
Fuel Tank (nominal capacity)	27 gal.	
Steering Gear Type	Integral Power	
Transmission	4-Speed Automatic w/Overdrive	3-Speed Automatic
Shift Location	Steering Column	
Tires	(5) P235/75R15 XL All Seasons Steel Belted Radial	Fr. (2) LT235/85R16D (8PR) Rr. (2) LT235/85R16E (10PR)
Wheels	(5) Disc 15" x 6"	(4) Disc 16" x 6.5"

♦CCA-Cold Cranking Amps

GASOLINE

C/K SUBURBAN—4-Wheel Drive

STANDARD SPECIFICATIONS

(See Gray Tab Section for Specification Details)

Series	K10/1500	K20/2500
Engine	5.7 Liter, 350 4-bbl. V8	
Base Equip.	12"; 150 sq. in.	
Clutch	Oiled-paper Element	
Air Filter	Throwaway Type	
Oil Filter	*Single; Aluminized	
Exhaust System	See Engine & Cooling Section for specific model applications	
Emission Control Systems		
Suspension, Front	Salisbury Axle, Hypoid Drive; Single-stage 2-leaf Springs	
Capacity	3600 lb.	3800 lb.
Axle Ratio	3.42	3.42
Springs @ Ground	1850 lb. ea.	1850 lb. ea.
Shock Absorbers	25mm dia.	32mm dia.
Stabilizer Bar	1.25" dia.	1.25" dia.
Hubs, Manual Locking	Standard	Standard
Suspension, Rear	Salisbury Axle, Hypoid Drive; Two-stage Multi-leaf Springs	
Axle Capacity	4000 lb.	6000 lb.
Axle Ratio	3.42	3.42
Springs @ Ground	2000 lb. ea.	3000 lb. ea.
Shock Absorbers	25mm dia.	32mm dia.
Brakes	Hydraulic; Self-adjusting	
Front	Disc; 11.86" Rotor	Disc; 12.5" Rotor
Rear	Drum; 11.15" x 2.75"	Drum; 13" x 2.5"
Booster	Dual Diaphragm	
Parking	Cable to Rear Wheels	
Electrical	12 Volt; Negative Ground	
Battery—Freedom Type	405 CCA ♦ @ 0°F.	
—Reserve Capacity	75 min. @ 80°F.	
Delcotron Generator	37 amp.	
Frame	Carbon Steel; 36,-39,000 psi	
Section Modulus	3.57	3.88
Fuel Tank (nominal capacity)	25 gal.	
Steering Gear Type	Integral Power	
Transmission	4-Speed Manual	
Shift Location	Floor	
Transfer Case	New Process 208 2-Speed	
Shift Lever	Single Lever	
Tires	(5) P215/75R15 All Seasons Steel Belted Radial	Fr. (2) LT235/85R16D (8PR) Rr. (2) LT235/85R16E (10PR)
Wheels	(5) Disc 15" x 6"	(4) Disc 16" x 6.5"

*Dual tail pipe on K10/1500 model.

♦CCA-Cold Cranking Amps.

C/K SUBURBAN—4-Wheel Drive

DIESEL

STANDARD SPECIFICATIONS

(See Gray Tab Section for Specification Details)

Series	K10/1500	K20/2500
Engine	6.2 Liter, 379 Cu. In. V8 Diesel	
Base Equip.	Poly-wrapped, Oiled-paper Element	
Air Filter	Throwaway Type	
Oil Filter	Standard	
Oil Cooler	Dual; Aluminized	
Exhaust System	See Engine & Cooling Section for specific model applications	
Emission Control Systems		
Suspension, Front	Salisbury Axle, Hypoid Drive; Single-stage 2-leaf Springs	
Capacity	3600 lb.	3800 lb.
Axle Ratio	3.42	3.73
Springs @ Ground	1850 lb. ea.	1850 lb. ea.
Shock Absorbers	25mm dia.	32mm dia.
Stabilizer Bar	1.25" dia.	1.25" dia.
Hubs, Manual Locking	Standard	Standard
Suspension, Rear	Salisbury Axle, Hypoid Drive; Two-stage Multi-leaf Springs	
Axle Capacity	4000 lb.	6000 lb.
Axle Ratio	3.42	3.73
Springs @ Ground	2000 lb. ea.	3000 lb. ea.
Shock Absorbers	25mm dia.	32mm dia.
Brakes	Hydraulic; Self-adjusting	
Front	Disc; 11.86" Rotor	Disc; 12.5" Rotor
Rear	Drum; 11.15" x 2.75"	Drum; 13" x 2.5"
Booster	Hydraulic Power	
Parking	Cable to Rear Wheels	
Electrical	12 Volt; Negative Ground	
Battery—Freedom Type	Two; 550 CCA ♦ ea. @ 0° F.	
—Reserve Capacity	115 min. ea. @ 80° F.	
Delcotron Generator	66 amp.	
Engine Block Heater	600 watts, 120 volts	
Frame	Carbon Steel; 36,-39,000 psi	
Section Modulus	3.57	3.88
Fuel Tank (nominal capacity)	27 gal.	
Steering Gear Type	Integral Power	
Transmission	4-Speed Automatic w/Overdrive	3-Speed Automatic
Shift Location	Steering Column	
Transfer Case	New Process 208 2-Speed	
Shift Lever	Single Lever	
Tires	(5) P235/75R15 All Seasons Steel Belted Radial	Fr. (2) LT235/85R16D (8PR) Rr. (2) LT235/85R16E (10PR)
Wheels	(5) Disc 15" x 6"	(4) Disc 16" x 6.5"

♦ CCA-Cold Cranking Amps.

GASOLINE

C/K SUBURBAN

Body Ordering Codes:
 Panel Rear Doors—ZW9
 Endgate—E55†

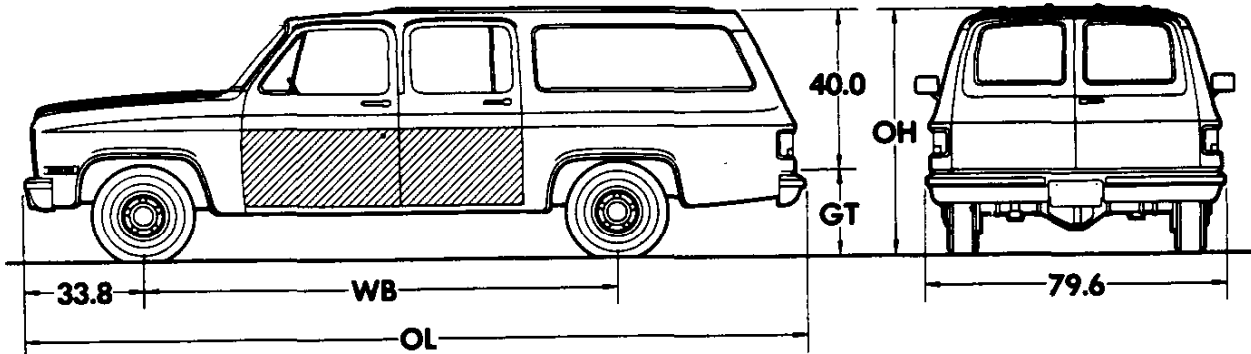

Capacity—165 cu ft
 Load Floor Area—40 sq ft

Sign Panel Area (side)
 22" x 72 1/4"



Series	Ground Clearance (in)*	
	Front	Rear
C1	6.6	6.7
C2	8.5	8.5
K1	6.9	7.1
K2	8.6	8.6

Model	Engine No. Cyl.	Dimensions (in)*				†Curb Weight (lb)			†Model Weight (lb)*		
		WB	OL	OH	GT	Front	Rear	Total	Front	Rear	Total

C10/1500 SERIES

C10906	8	129.5	219.1	72.0	29.0	2026	2285	4311	2369	2392	4761
---------------	---	-------	-------	------	------	------	------	------	------	------	------

C20/2500 SERIES

C20906	8	129.5	219.1	74.3	31.7	2315	2390	4705	2558	2597	5155
---------------	---	-------	-------	------	------	------	------	------	------	------	------

K10/1500 SERIES

K10906	8	129.5	219.1	73.8	30.1	2485	2230	4715	2728	2437	5165
---------------	---	-------	-------	------	------	------	------	------	------	------	------

K20/2500 SERIES

K20906	8	129.5	219.1	76.1	33.6	2561	2425	4986	2804	2632	5436
---------------	---	-------	-------	------	------	------	------	------	------	------	------

*Dimensions with standard equipment, unloaded.

*Model Weight includes Curb Weight plus occupants (standard seating capacity x 150 lb). Total Model Weight may vary as much as ±50 lbs. to allow for production build variation.

†Curb Weights and Model Weights shown are for models with ZW9 Panel Rear Doors. For models with E55 Endgate, weights must be adjusted as follows: Front -7 lb.; Rear +41 lb.; Total added weight 34 lb.

C/K SUBURBAN

DIESEL

Body Ordering Codes:
Panel Rear Doors—ZW9/B3J
Endgate—E55/B3J†

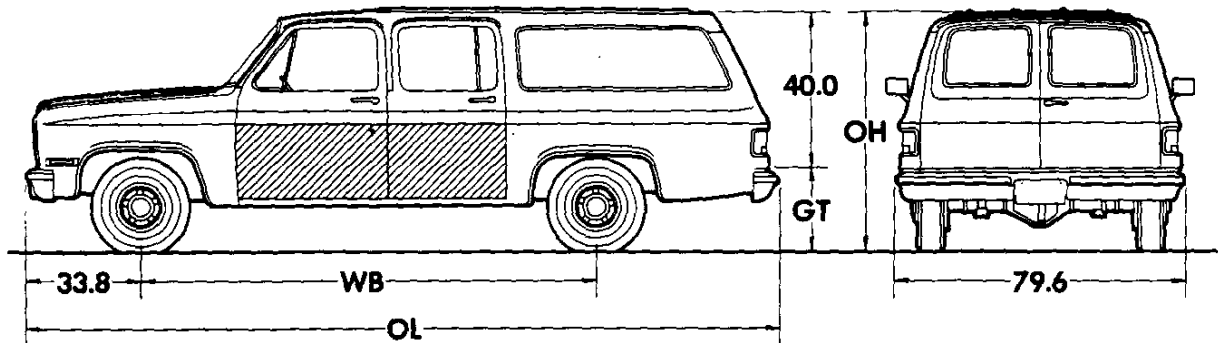

Capacity—165 cu ft
Load Floor Area—40 sq ft

Sign Panel Area (side)
22" x 72¼"



Series	Ground Clearance (in)*	
	Front	Rear
C1	6.6	6.7
C2	8.5	8.5
K1	6.9	7.1
K2	8.6	8.6

Model	Engine No. Cyl.	Dimensions (in)*				†Curb Weight (lb)			†Model Weight (lb)*		
		WB	OL	OH	GT	Front	Rear	Total	Front	Rear	Total

C10/1500 SERIES

C10906	8	129.5	219.1	72.0	29.0	2444	2387	4831	2787	2494	5281
---------------	---	-------	-------	------	------	------	------	------	------	------	------

C20/2500 SERIES

C20906	8	129.5	219.1	74.3	31.7	2677	2516	5193	2920	2723	5643
---------------	---	-------	-------	------	------	------	------	------	------	------	------

K10/1500 SERIES

K10906	8	129.5	219.1	73.8	30.1	2816	2360	5176	3059	2567	5626
---------------	---	-------	-------	------	------	------	------	------	------	------	------

K20/2500 SERIES

K20906	8	129.5	219.1	76.1	33.6	2912	2544	5456	3155	2751	5906
---------------	---	-------	-------	------	------	------	------	------	------	------	------

*Dimensions with standard equipment, unloaded.

*Model Weight includes Curb Weight plus occupants (standard seating capacity x 150 lb). Total Model Weight may vary as much as ±50 lbs. to allow for production build variation.

†Curb Weights and Model Weights shown are for models with ZW9 Panel Rear Doors. For models with E55 Endgate, weights must be adjusted as follows: Front -7 lb.; Rear +41 lb.; Total added weight 34 lb.

C/K SUBURBAN

POWER TEAMS

ALL STATES EXCEPT CALIFORNIA

POWER TEAMS (MUST ORDER ENGINE, TRANSMISSION AND REAR AXLE)
 (Consult GVWR Selector and Tire Chart to insure tire capacity and availability)

ENGINE	TRANSMISSION		AXLES				GVWR
	4-SP	AUTO	2.73	3.08	3.42	3.73	
W/NA5 STANDARD EMISSION EQUIPMENT							
-C10906							
LE9 V8 5.0 Liter (305-4BBL)		MXO	—	GQ1	GU6	—	61/6800
LS9 V8 5.7 Liter (350-4BBL)		MXO	GQ1	GU4	—	#GT4	6100
		MXO	—	GQ1	GU6	#GT4	6800
LH6 Diesel 6.2 Liter V8 (379 Cu In)(Reqs B3J)		MXO	—	GQ1	GU6	#GT4	7000
-K10906							
LS9 V8 5.7 Liter (350-4BBL)	MM4		—	—	GQ1	GT4	61/7000
		MXO	—	—	GQ1	—	61/7000
LH6 Diesel 6.2 Liter V8 (379 Cu In)(Reqs B3J)		MXO	—	—	GQ1	GT4	70/7300
W/NA6 HIGH ALTITUDE EMISSION EQUIPMENT							
-C10906							
LE9 V8 5.0 Liter (305-4BBL)		MXO	—	GQ1	GU6	—	61/6800
LS9 V8 5.7 Liter (350-4BBL)		MXO	—	—	GQ1	GT4	61/6800
LH6 Diesel 6.2 Liter V8 (379 Cu In)(Reqs B3J)		MXO	—	—	GQ1	GT4	7000
-K10906							
LS9 V8 5.7 Liter (350-4 BBL)	MM4		—	—	GQ1	GT4	61/7000
		MXO	—	—	GQ1	—	61/7000
LH6 Diesel 6.2 Liter V8 (379 Cu In)(Reqs B3J)		MXO	—	—	GQ1	GT4	70/7300

#Reqs Z82 Trailing Special

CALIFORNIA ONLY

POWER TEAMS (MUST ORDER ENGINE, TRANSMISSION AND REAR AXLE)
 (Consult GVWR Selector and Tire Chart to insure tire capacity and availability)

ENGINE	TRANSMISSION		AXLES				GVWR
	4-SP	AUTO	2.73	3.08	3.42	3.73	
W/YF5 CALIFORNIA EMISSION REQUIREMENTS							
-C10906							
LS9 V8 5.7 Liter (350-4 BBL)		MXO	—	GQ1	GU6	—	61/6800
LH6 Diesel 6.2 Liter V8 (379 Cu In)(Reqs B3J)		MXO	—	GQ1	GU6	—	7000
-K10906							
LS9 V8 5.7 Liter (350-4BBL)		MXO	—	—	GQ1	GT4	61/7000
LH6 Diesel 6.2 Liter V8 (379 Cu In)(Reqs B3J)		MXO	—	—	GQ1	GT4	70/7300

#Reqs Z82 Trailing Special

C/K SUBURBAN

POWER TEAMS

ALL STATES

POWER TEAMS (MUST ORDER ENGINE, TRANSMISSION AND REAR AXLE)
 (Consult GVWR Selector and Tire Chart to insure tire capacity and availability)

W/NA5 STANDARD Satisfies High Altitude Emission Requirements), NA6 HIGH ALTITUDE ■ OR YF5 CALIFORNIA EMISSIONS

ENGINE	TRANSMISSION				*3.21	3.42	3.73	4.10	4.56	GVWR
	4-SP	AUTO								
-C20906										
§§LT9 V8 5.7 Liter (350-4BBL)	MM4				—	GQ1	GT4	GT5	—	8600
		MX0/1			—	—	GQ1	GT5	HC4	8600
§§LE8 V8 7.4 Liter (454-4BBL) (Reqs N41 and UA1)		MX1			*GQ1	—	GT4	GT5	—	8600
		MX0/1			—	—	GQ1	GT5	HC4	8600
LL4 Diesel 6.2 Liter V8 (379 Cu. In.)(Reqs B3J)		MX0/1			—	—	GQ1	GT5	HC4	8600
—K20906										
§§LT9 V8 5.7 Liter (350-4BBL)	MM4				—	GQ1	GT4	GT5	—	8600
		MX0/1			—	—	GQ1	GT5	—	8600
LL4 Diesel 6.2 Liter V8 (379 Cu. In.)(Reqs B3J)		MX0/1			—	—	GQ1	GT5	—	8600

*N/A G80 Locking Differential

§§N/A Na6 High Altitude Emissions. With NA5 Emissions Satisfies High Altitude Requirements

■ High Altitude Emission Equipment (FOR EXHAUST SMOKE REDUCTION PURPOSES AT HIGH ALTITUDE; NOT REQUIRED TO SATISFY HIGH ALTITUDE REGULATIONS)(REQS LL4 ENG)

ENGINE RATINGS

ALL STATES EXCEPT CALIFORNIA

SAE Net Ratings	*5.0 Liter 305 4-bbl V8	*5.7 Liter 350 4-bbl V8	**5.7 Liter 350 4-bbl V8	**7.4 Liter 454 4-bbl V8
Net Horsepower	160 @ 4400 rpm	165 @ 3800 rpm	160 @ 3800 rpm	230 @ 3800 rpm
Net Torque, lb-ft	235 @ 2000 rpm	275 @ 1600 rpm	250 @ 2800 rpm	360 @ 2800 rpm

SAE Net Ratings	*6.2 Liter 379 V8 Diesel	**6.2 Liter 379 V8 Diesel
Net Horsepower	130 @ 3600 rpm	148 @ 3600 rpm
Net Torque, lb-ft	240 @ 2000 rpm	246 @ 2000 rpm

*Engine with Light or Medium Duty Emissions (w/GVWR up to 8500 lb.)

**Engine with Heavy Duty Emissions (w/GVWR over 8500 lb.)

CALIFORNIA ONLY

SAE Net Ratings	*5.7 Liter 350 4-bbl V8	**5.7 Liter 350 4-bbl V8	**7.4 Liter 454 4-bbl V8
Net Horsepower	165 @ 3800 rpm	155 @ 4000 rpm	230 @ 3800 rpm
Net Torque, lb-ft	275 @ 1600 rpm	240 @ 2800 rpm	360 @ 2800 rpm

SAE Net Ratings	*6.2 Liter 379 V8 Diesel	**6.2 Liter 379 V8 Diesel
Net Horsepower	130 @ 3600 rpm	148 @ 3600 rpm
Net Torque, lb-ft	240 @ 2000 rpm	246 @ 2000 rpm

*Engine with Light or Medium Duty Emissions (w/GVWR up to 8500 lb.)

**Engine with Heavy Duty Emissions (w/GVWR over 8500 lb.)

C/K SUBURBAN

GVWR SELECTOR—ALL STATES

GVW Rating (lbs)	+GAWR (lbs)		Minimum Equipment Required for GVW Rating		
	Front	Rear	Tire Capacity (lbs ea)		Chassis Equipment
			Front	Rear	

C10/1500 SERIES

▲ 6100	3250	3686	1843	1843	Standard
▲ 6800	3250	3820	1984	1984	Stabilizer Bar (F59)
♦ 7000	3400	3820	1984	1984	Standard

K10/1500 SERIES

▲ 6100	3166	3166	1583	1583	Standard
● 7000	3600	3686	1843	1843	
♦ 7300	3600	3968	1984	1984	Center and Rear Seats (AS3)

†GAWR's shown are the maximum for each axle with equipment listed. Other GAWR's are available, and they are determined as the minimum capacity of either axle, springs or tires.

▲ Not available on diesel engine models.

● On diesel engine models, not available with Center and Rear Seats (AS3).

■ Center seat (AT5) available on all GVWRs; Center and Rear seats (AS3) available on 6800 or above GVWRs.

♦ Available on diesel engine models only.

FRONT AND REAR TIRE AVAILABILITY CHART—ALL STATES

C-K10/1500 SERIES

**Spare tire to match either front or rear tires must be ordered.
K10/1500 models require matching front and rear tread**

Description	Capacity (lbs ea)	Highway		On-Off Road		Spare
		Front	Rear	*Front	Rear	
TUBELESS						
#P215/75R15 Steel Belted Radial	1583	XCU	YCU	—	—	ZCU
#P215/75R15 Whitewall Steel Belted Radial	1583	XCV	YCV	—	—	ZCV
P235/75R15 Steel Belted Radial	1843	XFL —	YFL —	— *YES	— YES	ZFL ZES
P235/75R15 Whitewall Steel Belted Radial	1843	XFM	YFM	—	—	ZFM
P235/75R15 XL Steel Belted Radial	1984	XHA	YHA	—	—	ZHA
P235/75R15 Whitewall XL Steel Belted Radial	1984	XHB	YHB	—	—	ZHB

*On-Off road front tires available on K1 models only.

#K1 models only. Not available with Diesel Equipment Package (B3).

C/K SUBURBAN

GVWR SELECTOR—ALL STATES

GVW Rating (lbs)	†GAWR (lbs)		Minimum Equipment Required for GVW Rating		
			Tire Capacity (lbs ea)		Chassis Equipment
	Front	Rear	Front	Rear	

C20/2500 SERIES

8600	3800	6000	2623	3042	Standard
-------------	------	------	------	------	----------

K20/2500 SERIES

8600	3700	6000	2623	3042	Standard
-------------	------	------	------	------	----------

†GAWR's shown are the maximum for each axle with equipment listed. Other GAWR's are available, and they are determined as the minimum capacity of either axle, springs or tires.

FRONT AND REAR TIRE AVAILABILITY CHART—ALL STATES

C-K20/2500 SERIES

Spare tire to match either front or rear tires is available at extra cost.
K20/2500 models require matching front and rear tread

Description	Capacity (lbs ea)	Highway		On-Off Road		Spare
		Front	Rear	*Front	Rear	
TUBELESS						
LT235/85R16D Steel Belted Radial	2623	XYM	—	—	—	—
LT235/85R16E Steel Belted Radial	3042	—	YYN	—	— #YYT #YYT	ZYN #ZYT #ZYN
LT235/85R16E Steel Belted Radial	3042	XYN	YYN	— *XYT —	— YYT #YYT	ZYN ZYT #ZYN

*On-Off road front tires available on K2 models only.
#Available on C2 models only.

C/K SUBURBAN

THE FOLLOWING EQUIPMENT IS STANDARD ON DIESEL ENGINE MODELS (ALSO SEE STANDARD SPECIFICATIONS PAGES)

- Low Coolant Sensor
- Poly-wrapped Paper Element Air Cleaner
- Auxiliary Engine Oil Cooler provided with 4.56 ratio rear axle (in addition to cooler in radiator tank)
- Power Steering
- Engine Block Heater
- Water/fuel separator unit which incorporates a water sensor and sending unit, a fuel filter, a fuel heater and water drain capability
- Hydraulic Power-assisted Brakes
- K81 66-amp Generator
- Engine Oil Cooler (located in radiator tank)
- Dual 550 Cold Cranking Amp/115 min. Reserve Capacity Batteries
- HD Radiator
- Dual Exhaust System
- Additional Insulation:
 - Cab-to-fender insulators
 - Fiberglass hood insulator
 - Fiberglass engine compartment firewall insulator
 - Cowl side spray-on deadener
 - Driver compartment dash mat with increased mastic layer
 - Resinated cotton and mastic floor insulation
 - Full cowl interior trim panels with resinated cotton insulation
 - Full-length, foam-backed cloth headliner
- Warning Lights: Glow Plugs, Water-in-fuel (or fuel filter), and Low Coolant
- Diesel Engine Identification:
 - Hood ornament
 - Fender nameplates
 - Rear door or tailgate nameplate
 - “Diesel Fuel Only” filler cap and label

C-K SUBURBAN 1985 VEHICLES WITH STANDARD EQUIPMENT

Description	Model Number	Body Code	Wheel Base	Factory D&H(s)	List Price	Mfr's Suggested Retail Price★	Group Number
◆ 8-Cylinder 5.0 Liter (305 Cu. In.) 4 BBL V8 Gasoline Engine-Engine Ordering Code LE9							
C10/C1500 Series 2-Wheel Drive							
Panel Doors	CC/TC10906	ZW9			129.5*		
Tailgate	CC/TC10906	E55			129.5*		
◆ 8-Cylinder 5.7 Liter (350 Cu. In.) 4 BBL V8 Gasoline Engine-Engine Ordering Code LS9							
K10/K1500 Series 4-Wheel Drive							
Panel Doors	CK/TK10906	ZW9			129.5*		
Tailgate	CK/TK10906	E55			129.5*		
◆ 8-Cylinder 5.7 Liter (350 Cu. In.) 4 BBL V8 Gasoline Engine-Engine Ordering Code LT9							
C20/C2500 Series 2-Wheel Drive							
Panel Doors	CC/TC20906	ZW9			129.5*		
Tailgate	CC/TC20906	E55			129.5*		
K20/K2500 Series 4-Wheel Drive							
Panel Doors	CK/TK20906	ZW9			129.5*		
Tailgate	CK/TK20906	E55			129.5*		
◆ 8-Cylinder 6.2 Liter (379 Cu. In.) L.D. Diesels V8 Engine-Engine Ordering Code LH6							
C10/C1500 Series 2-Wheel Drive							
Panel Doors	CC/TC10906	ZW9&B3J			129.5*		
Tailgate	CC/TC10906	E55&B3J			129.5*		
K10/K1500 Series 4-Wheel Drive							
Panel Doors	CK/TK10906	ZW9&B3J			129.5*		
Tailgate	CK/TK10906	E55&B3J			129.5*		
◆ 8-Cylinder 6.2 Liter (379 Cu. In.) H.D Diesel V8 Engine-Engine Ordering Code LL4							
C20/C2500 Series 2-Wheel Drive							
Panel Doors	CC/TC20906	ZW9&B3J			129.5*		
Tailgate	CC/TC20906	E55&B3J			129.5*		
K20/K2500 Series 4-Wheel Drive							
Panel Doors	CK/TK20906	ZW9&B3J			129.5*		
Tailgate	CK/TK20906	E55&B3J			129.5*		

★ Manufacturer's Suggested Retail Prices do not include applicable destination charges, state and local taxes, license fees, optional equipment or special items or services.

◆ Refer to Power Team Chart for California Emission Certification Requirements.

OPTIONS WHEN INSTALLED BY GENERAL MOTORS

Description	Option Number	Factory D&H(s)	List Price	Mfr's Suggested Retail Price◇
Scottsdale/High Sierra: (See Interior and Exterior Color Selection Chart) Not available when YE9 is specified. Includes bright windshield and rear side window moldings, B84 Black Body Side Moldings, turn signal and side marker lamp bezels, bright taillight trim, dual horns, nameplates on front fender and instrument panel, U37 Cigarette Lighter, dome lamp with bright bezels, bright sill plates and special insulation. Also includes spare tire cover when spare tire is specified.				
Without B3J Diesel Equipment. Also includes B85 Headliner	Z82			
With B3J Diesel Equipment	Z82			
Silverado/Sierra Classic: Available only when custom vinyl or cloth seats are specified. Includes wheel opening moldings, custom steering wheel, YG3 Deluxe Molding Package, bright taillight trim and rear door or tailgate moldings, bright front turn signal and front side marker lamp bezels, fender nameplates, bright windshield and rear side window moldings, carpeting, bright sill plates, plastic door trim panels with storage pockets and bright brushed-finish accents, dual horns, visor mirror, B85 Bright Body Side Moldings, V22 Deluxe Front Appearance, nameplate on instrument panel, U37 Cigarette Lighter, dome lamp with bright bezels, special insulation, pillar trim panels, Z53 Voltmeter, Temperature, and Oil Pressure Gages. Also includes spare tire cover when spare tire is specified.				
Without B3J Diesel Equipment. Also includes B85 Headliner	YE9			
With B3J Diesel Equipment	YE9			

C-K SUBURBAN

OPTIONS WHEN INSTALLED BY GENERAL MOTORS

Description	Option Number	Factory D&H(a)	List Price	Mfr's Suggested Retail Price ◊
Seat Trim: Driver and Passenger. (See Interior and Exterior Color Selection Chart for ordering information)				
V**1 Vinyl Bench Seat. Not available when YE9 is specified				
L**1 Custom Cloth Bench Seat. Available only when Z62 or YE9 is specified.				
With Z62				
Without AT5 or AS3 Seats				
With AT5 Center Seat without AS3 Center and Rear Seats. Includes full floor mats				
With AS3 Center and Rear Seats. Includes full floor mats				
With YE9				
Without AT5 or AS3 Seats				
With AT5 Center Seat without AS3 Center and Rear Seats. Includes full carpeting				
With AS3 Center and Rear Seats. Includes full carpeting				
X**1 Custom Vinyl Bench Seat. Available only when Z62 or YE9 is specified.				
With Z62				
Without AT5 or AS3 Seats				
With AT5 Center Seat without AS3 Center and Rear Seats. Includes full floor mats				
With AS3 Center and Rear Seats. Includes full floor mats				
With YE9				
Without AT5 or AS3 Seats				
With AT5 Center Seat without AS3 Center and Rear Seats. Includes full carpeting				
With AS3 Center and Rear Seats. Includes full carpeting				
L**6 Custom Cloth Reclining Bucket Seats. Includes console				
Without AT5 or AS3 Seats				
With AT5 Center Seat without AS3 Center and Rear Seats. Includes full carpeting				
With AS3 Center and Rear Seats. Includes full carpeting				
X**6 Custom Vinyl Reclining Bucket Seats. Includes console				
Without AT5 or AS3 Seats				
With AT5 Center Seat without AS3 Center and Rear Seats. Includes full carpeting				
With AS3 Center and Rear Seats. Includes full carpeting				
Paints, Exterior: (See Interior and Exterior Color Selection Chart for ordering information).				
Solid				ZY1
Special Two-Tone.				
Without Z62 or YE9. Includes YG1 Custom Molding Package and wheel opening moldings				ZY3
With Z62. Includes YG1 Custom Molding Package and wheel opening moldings				ZY3
With YE9				ZY3
Exterior Decor Package. Includes dual-tone side, rear decal striping and hood ornament.				
Without Z62 or YE9. Also includes YG1 Custom Package, wheel opening moldings and hood accent stripes.				ZY5
With Z62. Also includes YG1 Custom Package, wheel opening moldings and hood accent stripes				ZY5
With YE9				ZY5
Emission Systems: Dealer Note - One of the following emission options must be specified. (See Power Teams Chart for availability and complete specifications)				
California Emission Requirements: Not available when V10 Cold-Climate Package, LE9 5.0 Liter Engine, NA5 Standard or NA6 High Altitude Emissions are specified. Includes all testing, equipment and/or certification necessary for registration in the State of California				
With LS9 5.7 Liter Engine				YF5
With LT9 5.7 Liter or LE8 7.4 Liter Engine				YF5
With B3J Diesel Equipment				YF5
High Altitude Emission Equipment. Not available when NA5 Standard or YF5 California Emissions are specified				
Standard Emission Equipment. Not available when YF5 California or NA6 High Altitude Emissions are specified				NA6
Standard Emission Equipment. Not available when YF5 California or NA6 High Altitude Emissions are specified				NA5

C-K SUBURBAN

OPTIONS WHEN INSTALLED BY GENERAL MOTORS

Description	Option Number	Factory D&H(a)	List Price	Mfr's Suggested Retail Price ◊
Engines: (See Power Teams Chart for availability and complete specifications)				
Gasoline.				
5.0 Liter (305 Cu. In.) 4 BBL V8. C1 Series only	LE9			
5.7 Liter (350 Cu. In.) 4 BBL V8. Standard on K1 Series. C1 Series only	LS9			
5.7 Liter (350 Cu. In.) 4 BBL V8. C-K2 Series only	LT9			
7.4 Liter (454 Cu. In.) 4 BBL V8. C2 Series only. Available only when N41 Power Steering and UA1 H.D. Battery are specified	LE8			
Diesel.				
6.2 Liter (379 Cu. In.) L.D. V8 Diesel. C-K1 Series only. Available only when B3J Diesel Equipment is specified	LH6			
6.2 Liter (379 Cu. In.) H.D. V8 Diesel. C-K2 Series only. Available only when B3J Diesel Equipment is specified	LL4			
Transmissions:				
4-Speed Manual. C2 or K1-2 Series only. Not available when LE8 7.4 Liter Engine or B3J Diesel Equipment is specified	MM4			
4-Speed Automatic Overdrive. Standard on C1 Gasoline and Diesel Series and K1 Diesel Series. Not available when LE8 7.4 Liter Engine is specified				
Without B3J Diesel Equipment	MX0			
With B3J Diesel Equipment	MX0			
3-Speed Automatic. C-K2 Series only. Standard with B3J Diesel Equipment	MX1			
Axles, Rear: (See Power Teams Chart for option number selection, availability and complete specifications)				
Optional Ratio				
Locking Differential	G80			
Tires: (See Tire Charts for Tire Availability)				
All rim sizes are 6.00" on C-K1 Series except when N87, N90 or PA6 wheels are specified.				
All rim sizes are 6.50" on C-K2 Series.				
TUBELESS				
P215/75R15 All Seasons Steel Belted Radial Ply Blackwall				
(Maximum Capacity 1583-lbs)				
K1 Series only. Not available when B3J Diesel Equipment is specified				
Front (Standard)	XCU			
Rear (Standard)	YCU			
Spare (Standard)	ZCU			
P215/75R15 All Seasons Steel Belted Radial Ply Whitewall.				
(Maximum Capacity 1583-lbs).				
Front	XCV			
Rear	YCV			
Spare	ZCV			
P235/75R15 All Seasons Steel Belted Radial Ply Blackwall				
(Maximum Capacity 1843-lbs)				
Front				
C1 Series only (Standard). Not available when B3J Diesel Equipment is specified	XFL			
K1 Series only				
Without B3J Diesel Equipment	XFL			
With B3J Diesel Equipment. (Standard)	XFL			
Rear				
C1 Series only (Standard). Not available when B3J Diesel Equipment is specified	YFL			
K1 Series only				
Without B3J Diesel Equipment	YFL			
With B3J Diesel Equipment	YFL			
Spare				
C1 Series only (Standard). Not available when B3J Diesel Equipment is specified	ZFL			
K1 Series only				
Without B3J Diesel Equipment	ZFL			
With B3J Diesel Equipment	ZFL			

C-K SUBURBAN

OPTIONS WHEN INSTALLED BY GENERAL MOTORS

Description	Option Number	Factory D&M(a)	List Price	Mfr's Suggested Retail Price◇
Tires: (Continued)				
<i>P235 /75R15 On-Off Road Steel Belted Radial Ply Blackwall</i>				
(Maximum Capacity 1843-lbs)				
Front. K1 Series only				XES
Rear				
C1 Series only. Not available when B3J Diesel Equipment is specified ..				YES
K1 Series only				YES
Spare				
C1 Series only. Not available when B3J Diesel Equipment is specified ..				ZES
K1 Series only				ZES
<i>P235/75R15 All Seasons Steel Belted Radial Ply Whitewall</i>				
(Maximum Capacity 1843-lbs)				
Front				
C1 Series only. Not available when B3J Diesel Equipment is specified ..				XFM
K1 Series only				XFM
Rear				
C1 Series only. Not available when B3J Diesel Equipment is specified ..				YFM
K1 Series only				YFM
Spare				
C1 Series only. Not available when B3J Diesel Equipment is specified ..				ZFM
K1 Series only				ZFM
<i>P235/75R15 All Seasons Steel Belted Radial Ply Blackwall</i>				
(Maximum Capacity 1984-lbs). Standard on C1 Series when B3J Diesel Equipment is specified				
Front				
C1 Series only				XHA
K1 Series only				XHA
Rear				
C1 Series only				YHA
K1 Series only				YHA
Spare				
C1 Series only				ZHA
K1 Series only				ZHA
<i>P235/75R15 All Seasons Steel Belted Radial Ply Whitewall</i>				
(Maximum Capacity 1984-lbs)				
Front				
C1 Series only				
Without B3J Diesel Equipment				XHB
With B3J Diesel Equipment				XHB
K1 Series only				XHB
Rear				
C1 Series only				
Without B3J Diesel Equipment				YHB
With B3J Diesel Equipment				YHB
K1 Series only				YHB
Spare				
C1 Series only				
Without B3J Diesel Equipment				ZHB
With B3J Diesel Equipment				ZHB
K1 Series only				ZHB
<i>LT235/85R16D Highway Steel Belted Radial Ply Blackwall</i>				
(Maximum Capacity 2823-lbs) C-K2 Series only.				
Front. (Standard)				XYM
<i>LT235/85R16E Highway Steel Belted Radial Ply Blackwall</i>				
(Maximum Capacity 3042-lbs). C-K2 Series only.				
Front				XYN
Rear. (Standard)				YYN
Spare				ZYN
<i>LT235/85R16E On-Off Road Steel Belted Radial Ply Blackwall</i>				
(Maximum Capacity 3042-lbs.)				
Front. K2 Series only				XYT
Rear. C-K2 Series only				YYT
Spare. C-K2 Series only				ZYT

C-K SUBURBAN

OPTIONS WHEN INSTALLED BY GENERAL MOTORS

Description	Option Number	Factory D&H(s)	List Price	Mfr's Suggested Retail Price ◊
OTHER OPTIONS				
Air Cleaner, Pre-Cleaner	K46			
Air Conditioning: All-Weather. Not available when V10 Cold-Climate Package is specified. Includes extra cooling.				
<i>Front.</i> Included when C69 Front and Rear Air Conditioning is specified.				
Recommended for front seat area cooling only.				
Without B3J Diesel Equipment Also includes K81 66-Amp Generator when C49 Defogger or C36 Rear Heater are not specified.				
Without Z62 or YE9 Also includes BB5 Headliner	C60			
With Z62 or YE9	C60			
With B3J Diesel Equipment	C60			
<i>Front and Rear.</i> Rear Interior Roof Mounted. Available only when YE9 or Z62 is specified. Rear system operates on recirculating air.				
Without B3J Diesel Equipment Also includes K81 66-Amp Generator when C49 Defogger or C36 Rear Heater are not specified				
With B3J Diesel Equipment	C69			
	C69			
Appearance, Deluxe Front: Included when YE9 is specified. Includes dark argent grille with bright trim and dual rectangular headlamps.				
	V22			
Batteries: 12-Volt. 515 Cold Cranking Amps Delco Freedom. Not available when B3J Diesel Equipment is specified.				
<i>Auxiliary</i>	TP2			
<i>Heavy-Duty.</i> Included when V10 Cold-Climate Package is specified	UA1			
Bumper Equipment:				
<i>Bumpers, Deluxe.</i> Front and Rear. Not available when V31 Bumper Guards are specified. Includes front and rear bumpers and black resilient impact strips ..				
	VE5			
<i>Guards, Chromed. Front Bumper</i>	V31			
Clock: Quartz Electric				
Without YE9. Includes Z53 Voltmeter, Temperature and Oil Pressure Gages ..	U35			
With YE9	U35			
Cold-Climate Package: Not available when B3J Diesel Equipment, C60 Front or C69 Front and Rear Air Conditioning is specified. Includes H.D. heater and defroster, K05 Engine Block Heater, anti-freeze protection to -32 degrees, and UA1 H.D. Battery.				
Without Z82 Trailering Special, C36 Rear Heater or C49 Defogger. Also includes K81 66-Amp Generator	V10			
With Z82 Trailering Special, C36 Rear Heater or C49 Defogger	V10			
Cooling System: Recommended for heavy-duty trailering.				
<i>Engine Oil.</i> Not available when B3J Diesel Equipment is specified	KC4			
<i>Radiator, Heavy-Duty.</i> Not available when B3J Diesel Equipment, C60 Front or C69 Front and Rear Air Conditioning is specified. C-K2 Series also not available when MX0 or MX1 Automatic Transmission is specified	V01			
<i>Radiator and Transmission Oil, Heavy-Duty.</i> Available only when MX0 or MX1 Automatic Transmission is specified. Not available when V01 H.D. Raditor is specified. Included when Z82 Trailering Special is specified.	V02			
Defogger, Rear Window: Electric. Available only when A33 Power Tailgate Window is specified. Not available when AJ1 Deep Tinted Glass is specified.				
Without C60 Front or C69 Front and Rear Air Conditioning, B3J Diesel Equipment, C36 Rear Heater or Z82 Trailering Special. Includes K81 66-Amp Generator	C49			
With C60 Front or C69 Front and Rear Air Conditioning, B3J Diesel Equipment or Z82 Trailering Special without C36 Rear Heater	C49			
With C36 Rear Heater	C49			
Door Lock System, Power: Available only when BB5 Headliner, B3J Diesel Equipment, Z62, YE9, C60 Front or C69 Front and Rear Air Conditioning is specified. Included when ZQ2 Operating Convenience Package is specified.				
<i>Side Doors</i>				
With E55 Body. Side doors only	AU3			
With ZW9 Body. Also includes AU6 Rear Door Lock	AU3			
<i>Rear Door.</i> Available only when ZW9 Body is specified. Included with AU3 Side Door Locks or ZQ2 Operating Convenience Package when ZW9 Body is specified				
	AU6			

C-K SUBURBAN

OPTIONS WHEN INSTALLED BY GENERAL MOTORS

Description	Option Number	Factory D&H(a)	List Price	Mfr's Suggested Retail Price ◊
OTHER OPTIONS				
Floor Covering: Mats, Color-Keyed, Floor, Removable Available only when YE9 is specified				
Front only	B32			
Rear only. Available only when B32 Front Mats are specified	B33			
Gages: Voltmeter, Temperature and Oil Pressure. Included when YE9 or U35 Electric Clock is specified				
	Z53			
Generator: 66-Amp Delcotron. Not available when C36 Rear Heater is specified with C49 Defogger. Included when Z82 Trailing Special, C60 Front or C69 Front and Rear Air Conditioning, B3J Diesel Equipment, V10 Cold-Climate Package, C36 Rear Heater or C49 Defogger is specified				
	K81			
Glass:				
<i>Deep Tinted.</i> Not available when C49 Defogger is specified. Includes tinted glass on passenger and driver's side door. Also includes dark laminated glass on side windows and rear door				
	AJ1			
<i>Deep Tinted with Light Tinted Rear Window.</i> Not available when AJ1 Deep Tinted Glass is specified. Includes tinted glass on passenger, driver's side and rear doors. Also includes dark laminated glass on side windows				
	AA3			
Harness, Trailer Wiring: Heavy-Duty 7-Lead. Included when Z82 Trailing Special is specified				
	UY7			
Headlamps: Halogen Hi-Beam. Available only when V22 Deluxe Front Appearance Package or YE9 is specified				
	TT5			
Headlamp Warning Buzzer				
	T63			
Headliner, Interior: Full Length. Included when YE9, Z82, B3J Diesel Equipment, C60 Front or C69 Front and Rear Air Conditioning is specified. Includes dome lamp				
	B85			
Heaters:				
<i>Engine Block. 600 Watts, 120 Volts.</i> Not available when B3J Diesel Equipment is specified. Included when V10 Cold-Climate Package is specified				
	K05			
<i>Rear.</i> Located on lower of rear fender well. <i>right side, rear</i>				
Without C60 Front or C69 Front and Rear Air Conditioning, B3J Diesel Equipment, C49 Defogger or Z82 Trailing Special. Includes K81 66-Amp Generator				
	C38			
With C60 Front or C69 Front and Rear Air Conditioning, B3J Diesel Equipment, C49 Defogger or Z82 Trailing Special				
	C38			
<i>Front. Heavy Duty.</i> Available only when B3J Diesel Equipment is specified. Not available when C60 Front or C69 Front and Rear Air Conditioning is specified				
	C42			
Lamps: Roof Marker. Five. Not available when YF5 California Emissions is specified. Available only when K81 66-Amp Generator is specified				
	U01			
Lighter, Cigarette: Included when YE9 or Z82 is specified				
	U37			
Mirrors, Exterior: LH and RH.				
<i>Below-Eye-Line Type. 9" x 6.5"</i>				
Painted				
	D44			
Stainless Steel				
	D46			
<i>Camper Type. 7.5" x 10.5".</i> Stainless steel. Adjustable arm feature to provide field of vision for vehicles to 96" wide. Shipped loose for dealer installation				
	DF2			
Moldings:				
<i>Body Side, Black.</i> Bright with black insert. Not available when YE9, B85 Bright Body Side Molding or YG3 Deluxe Molding Package is specified. Included when YG1 Custom Molding Package, ZY3 Special Two-Tone Paint, ZY5 Exterior Decor Package or Z62 is specified. Includes lower side and rear moldings of black plastic with bright trim				
	B84			
<i>Body Side, Bright.</i> Not available when ZY3 Special Two-Tone Paint, ZY5 Exterior Decor Package, B84 Black Body Side Moldings or YG1 Custom Molding Package is specified. Included when YG3 Deluxe Molding Package or YE9 is specified. Includes bright plastic body side and rear lower moldings with black paint trim plus bright trim for front side marker lamps and taillights				
Without Z62				
	B85			
With Z62				
	B85			
<i>Custom Package.</i> Not available when B85 Bright Body Side Moldings, YE9 or YG3 Deluxe Molding Package is specified. Included when ZY3 Special Two-Tone Paint or ZY5 Exterior Decor Package is specified. Includes bright trim for front side marker lamps and taillights, B84 Black Body Side and wheel opening moldings.				
Without Z62				
	YG1			
With Z62				
	YG1			

C-K SUBURBAN

OPTIONS WHEN INSTALLED BY GENERAL MOTORS

Description	Option Number	Factory D&H(s)	List Price	Mfr's Suggested Retail Price [◇]
OTHER OPTIONS				
Moldings: (Continued)				
<i>Deluxe Package.</i> Included when YE9 is specified. Includes B85 Bright Body Side Moldings, bright trim for front side marker lamps and taillights and wheel opening moldings.				
Without ZY3 Special Two-Tone Paint, Z62 or ZY5 Exterior Decor Package	YG3			
With ZY3 Special Two-Tone Paint or ZY5 Exterior Decor Package	YG3			
With Z62	YG3			
<i>Guards, Door Edge</i>	B93			
Operating Convenience Package: Available only when Z62, YE9, B3J Diesel Equipment, C60 Front or C69 Front and Rear Air Conditioning or BB5 Interior Headliner is specified. Includes A31 Power Windows and AU3 Power Side Door Locks				
With E55 Body	ZQ2			
With ZW9 Body. Also includes AU6 Rear Door Lock	ZQ2			
Preliminary Price Information	B3W			
Radio Equipment:				
<i>AM Radio</i>	U63			
<i>AM/FM Radio</i>	U69			
<i>AM/FM Stereo Radio</i>	U58			
<i>AM/FM Stereo Radio with Stereo Cassette Tape</i>	UN3			
<i>Windshield Antenna.</i> Included with Radio	U76			
Seats: Seat trim matches front seat whether standard or optional. Includes seat area floor covering, floor insulation and (3) seat belts. <i>Dealer Note</i> - One of the following seat options must be specified. (Added weight includes passenger weight allowance of 150-lbs per seating position. Refer to vehicle and option weight section of Data Book).				
<i>Center only.</i> Non-adjustable type with independent LH and RH folding sections <i>Center and Rear.</i> Includes non-adjustable center and quick release removable type rear seats. (3) additional seat belts plus LH and RH rear arm rests with ashtrays.	AT5			
C1 Series only. Available only when HA or HB P235/75R15 Tires are specified.				
Without B3J Diesel Equipment. Also includes F59 Stabilizer	AS3			
With B3J Diesel Equipment	AS3			
C-K2 or K1 Series only. K1 Series available only when HA or HB P235/75R15 Tires are specified				
	AS3			
<i>Optional Seat Not Desired</i>	YG4			
Shield, Fuel Tank:				
C1-2 Series only.				
Without NE2 Fuel Tank	NY1			
With NE2 Fuel Tank	NY1			
K1-2 Series only. Includes transfer case skid plate.				
Without NE2 Fuel Tank	NY1			
With NE2 Fuel Tank	NY1			
Shock Absorbers: Front and Rear, Heavy-Duty. C1 Series only. Standard on C-K2 Series. Included when Z82 Trailing Special is specified				
	F51			
Shocks, Front Quad: K1-2 Series only. Includes dual left and right hand shock absorbers on front, heavy-duty shock absorbers on rear and a front axle nose bumper to limit axle windup.				
K1 Series only	Z75			
K2 Series only	Z75			
Speed Control, Electronic: Not available when MM4 4-Speed Transmission is specified				
	K34			
Springs: Front, Heavy-Duty. Capacity 2250-lb each.				
K1 Series only. Recommended for snowplow type usage only.				
Without Z75 Front Quad Shock Absorbers. Includes H.D. front and rear shock absorbers	F60			
With Z75 Front Quad Shock Absorbers	F60			
K2 Series only	F60			

C-K SUBURBAN

OPTIONS WHEN INSTALLED BY GENERAL MOTORS

Description	Option Number	Factory D&H(a)	List Price	Mfr's Suggested Retail Price ◊
OTHER OPTIONS				
Stabilizers:				
<i>Front.</i> 1" diameter. C1 Series only. Included when AS3 Seats or B3J Diesel Equipment is specified	F59			
<i>Front, Heavy-Duty.</i> 1.25" diameter. C2 Series only. Standard on K1-2 Series	F58			
Steering:				
<i>Power.</i> Standard on K1-2 Series. Included when Z82 Trailing Special or B3J Diesel Equipment is specified	N41			
<i>Power, Not Desired.</i> C1-2 Series only. Not available when Z82 Trailing Special or B3J Diesel Equipment is specified	N51			
Steering Wheel: <i>Comfortilt</i>	N33			
Tanks, Fuel: Replaces production fuel tank.				
Approximately 31-Gallon Capacity for Gasoline and 32-Gallon Capacity for Diesel	NK7			
Approximately 40-Gallon Capacity for Gasoline and 41-Gallon Capacity for Diesel	NE2			
Towing Device: <i>Two front towing hooks.</i>	V76			
Trailer Hitch:				
<i>Deadweight Type.</i> Not available when Z82 Trailing Special is specified	VR2			
<i>Weight Distributing Platform Type.</i> Not available when VR2 Deadweight Type Trailer Hitch is specified. Included when Z82 Trailing Special is specified	VR4			
Trailing Special Equipment: Includes VR4 Weight Distributing Hitch Platform, UY7 Wiring Harness and V02 H.D. Radiator Transmission Oil Cooler. (See Trailing Guide in Recreational Vehicles Section, for GCW Ratings with available power team combinations.)				
C1 Series only. Available only when 3.73 or 3.42 rear axle ratio is specified. With B3J Diesel Equipment not available when YF5 California Emissions are specified. Also includes F51 H.D. Shock Absorbers.				
Without B3J Diesel Equipment. Available only when LS9 5.7 Liter Engine is specified. Also includes KC4 Engine Oil Cooler and N41 Power Steering.				
Without C60 Front or C69 Front and Rear Air Conditioning, C36 Rear Heater or C49 Defogger. Also available only when V01 H.D. Radiator is specified. Also includes K81 66-amp generator	Z82			
With C60 Front or C69 Front and Rear Air Conditioning, C49 Defogger or C36 Rear Heater	Z82			
With B3J Diesel Equipment	Z82			
C2 Series only. Available only when MX0 or MX1 Automatic Transmission is specified.				
Without B3J Diesel Equipment. Also includes N41 Power Steering and KC4 Engine Oil Cooler.				
Without C60 Front or C69 Front and Rear Air Conditioning, C36 Rear Heater or C49 Defogger. Also includes K81 66-Amp Generator	Z82			
With C60 Front or C69 Front and Rear Air Conditioning, C36 Rear Heater or C49 Defogger	Z82			
With B3J Diesel Equipment	Z82			
K1-2 Series only. K2 Series available only when MX0 or MX1 Automatic Transmission is specified. LT9 5.7 Liter Engine on K2 Series also available only when 4.10 Rear Axle Ratio is specified. K1 Series available only when MX0 Automatic Transmission and 3.42 or 3.73 Rear Axle Ratio is specified. K1 Series also requires V01 H.D. Radiator unless C60 Front or C69 Front and Rear Air Conditioning is specified.				
Without B3J Diesel Equipment. Also includes KC4 Engine Oil Cooler.				
Without C60 Front or C69 Front and Rear Air Conditioning, C36 Rear Heater or C49 Defogger. Also includes K81 66-Amp Generator	Z82			
With C60 Front or C69 Front and Rear Air Conditioning, C36 Rear Heater or C49 Defogger	Z82			
With B3J Diesel Equipment	Z82			
Wheel Trim:				
<i>Wheel Covers.</i> C-K1 Series only	P01			
<i>Wheel Covers, Special. Bright Metal.</i> C-K2 Series only	PA1			
Wheels: C-K1 Series only.				
<i>Rally.</i> Includes special hub caps, trim rings and 15" x 8" wheels. Not available when P215/75R15 tires are specified	N67			
<i>Styled.</i> K1 Series only. Four Wheels only. Includes 15" x 8" wheels. Not available when P215/75R15 tires are specified	PA6			
<i>Aluminum, Cast.</i> Four Wheels only. Includes 15" x 7" wheels and special hub caps	N90			

C-K SUBURBAN

OPTIONS WHEN INSTALLED BY GENERAL MOTORS

Description	Option Number	Factory D&H(a)	List Price	Mfr's Suggested Retail Price [◇]
OTHER OPTIONS				
Windows: Electric.				
<i>Power Side Door Glass.</i> Available only when BB5 Headliner, Z62, YE9, B3J Diesel Equipment, C80 Front or C89 Front and Rear Air Conditioning is specified. Included when ZQ2 Operating Convenience Package is specified	A31			
<i>Power Tailgate.</i> Available only when E55 Tailgate is specified	A33			
Windshield Wiper System: Intermittent	CD4			

NOTES

C/K SUBURBAN

**CAB & BODY FEATURES
CAB DIMENSIONS
SEATING ARRANGEMENTS
COLOR & TRIM CHARTS
TWO-TONES**

C/K SUBURBAN

CUSTOM DELUXE/SIERRA FEATURES—STANDARD MODEL

The Custom Deluxe/Sierra standard models include the following items as standard equipment



EXTERIOR

- **Bumpers:** Front and rear; chromed
- **Color:** See Interior and Exterior Color Selection Chart
- **Doors:** Four side doors, two LH and two RH; two rear panel doors (optional endgate with drop-glass available)
- **Glass:** Tinted; all windows; includes shade band on upper windshield
- **Grille and Headlamp Bezels:** Molded plastic; painted argent; integral Chevrolet emblem/GMC letters at center of grille
- **Horn:** Single, electric, low-note
- **Hub Caps:** Bright metal with black trim
- **Keys:** Two-key system with separate keys for ignition switch and door locks
- **Lights:**
 - Backup lamps: Two rear (integral with taillamps)
 - Combination parking/direction/hazard: Two front
 - Combination tail/stop/direction/hazard: Two rear
 - Headlamps: Two, rectangular
- **License plate lamp:** Single rear
- **Side marker lamps with reflectors:** Two front; two rear (integral with taillamps)
- **Mirrors:** RH and LH fixed arm with adjustable 5-7/16" wide x 4" high head; chrome finish
- **Moldings:** Bright; drip moldings over side and rear doors; headlamp and grille outline moldings
- **Nameplates:** Bright "Custom Deluxe/Sierra" nameplates, with series designation, on front fenders near doors; bright "Suburban" nameplate on RH rear door
- **Tools:** Mechanical jack and wheel wrench
- **Wheels:** Painted white
- **Windshield Wipers and Washers:** Electric, 2-speed wipers with bright finish on exposed metal portions; wet-arm demand-type washer system



C/K SUBURBAN

CUSTOM DELUXE/SIERRA FEATURES—STANDARD MODEL

The Custom Deluxe/Sierra standard models include the following items as standard equipment

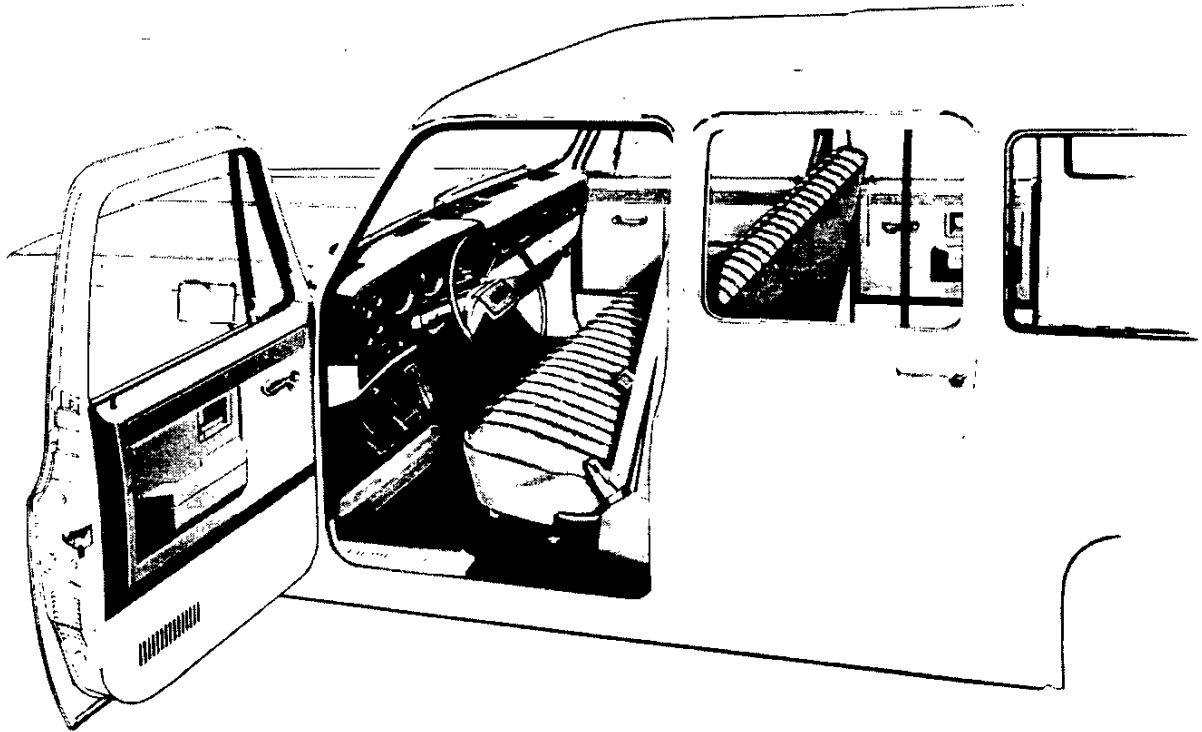

INTERIOR

- **Armrests:** RH and LH padded; integral with side door trim panels
- **Ashtrays:** In middle of instrument panel and in rear side door trim panels
- **Coat Hooks:** Over RH and LH rear side door openings
- **Colors:**
Painted areas: Same as exterior primary color choice
Interior trim: Coordinated with seat trim color choices
- **Floor Covering:** Embossed black rubber mats over entire floor area; color-keyed carpeting on rear face of seat backs on center seats (when optional center seats are ordered)
- **Heater and Defogger:** Deluxe-air
- **Hood Lock Release:** Handle located on LH side under instrument panel
- **Instrument Cluster Bezel:** Black crackle finish with bright trim
- **Instruments:**
Gages: Speedometer, odometer and fuel
Switches: Main, for control of exterior lights, instrument cluster lights, and interior lights; multi-function switch on steering column for direction signals by moving lever up or down (includes lane change position), headlamp beams by pulling lever toward driver, windshield wiper by turning band marked "WIPER" toward or away from driver, and windshield washer by pushing in the lever knob; ignition with key-in warning buzzer; hazard warning; heater fan
Warning lights: Generator, oil pressure, engine temperature, seat belt, service-parking brake, direction/hazard signal, high beam
- **Instrument Panel Control Knobs:** Soft black plastic (except heater and wiper-washer controls) with white graphic identification
- **Instrument Panel Pad:** Color-keyed, energy-absorbing foam type with grained vinyl skin; has black crackle finish applique on RH side with bright, black, and silver trim and bright "Custom Deluxe/Sierra" nameplate
- **Insulation and Sound Deadening Material:** Dash (firewall), under floor mats and under front seat at center (includes extra-thick insulation in center seat area when optional seat is ordered)
- **Lights:** Instrument cluster and cab interior lights
- **Mirror, Rearview:** 10" prismatic with soft vinyl rim
- **Seat:** Full-width, full-depth foam bench-type front seat only with embossed grained all-vinyl trim. See Interior and Exterior Color Selection Chart for color and trim availability
- **Seat Belts:** Front only; non-detachable combination lap and shoulder belts for outboard positions with automatic-locking retractors on lap belts; emergency-locking retractors on shoulder belts, and switch in driver's lap belt retractor for buzzer warning system; lap belt with manual adjustment for center position. All seat belts are color-keyed with pushbutton type buckles
- **Sill Plates:** Door-opening protection and floor mat retention; bright metal; partial for front side doors, full-length for rear side doors, and full-width front and rear for rear compartment platform
- **Spare Tire Carrier:** LH rear side
- **Steering Wheel and Column:** 16" black, soft plastic wheel with 2 spokes; black energy-absorbing steering column with anti-theft locking feature
- **Stowage Box:** In RH side of instrument panel; door has bright turn-type latch release
- **Sunshades:** RH and LH padded; color-keyed
- **Trim Panels:** Color-keyed, embossed molded plastic on side doors with integral armrests; painted steel panels on rear quarter areas

C/K SUBURBAN

SCOTTSDALE/HIGH SIERRA MODEL OPTION—RPO Z62

This option includes all Custom Deluxe/Sierra standard model items plus the additions or substitutions listed below



Chevrolet model shown (GMC model available)

EXTERIOR

• **Bright Appearance Items:**

- "Scottsdale/High Sierra" nameplates, with series designation, on front fenders
- Body side and rear molding trim
- Chevrolet emblem/GMC letters at grille center
- Dome lamp trim

- Side marker lamp and taillamp trim
- Windshield reveal moldings
- Rear side window trim
- **Horn:** Additional, electric, high-note
- **Moldings:** Black plastic body side and rear moldings with bright trim

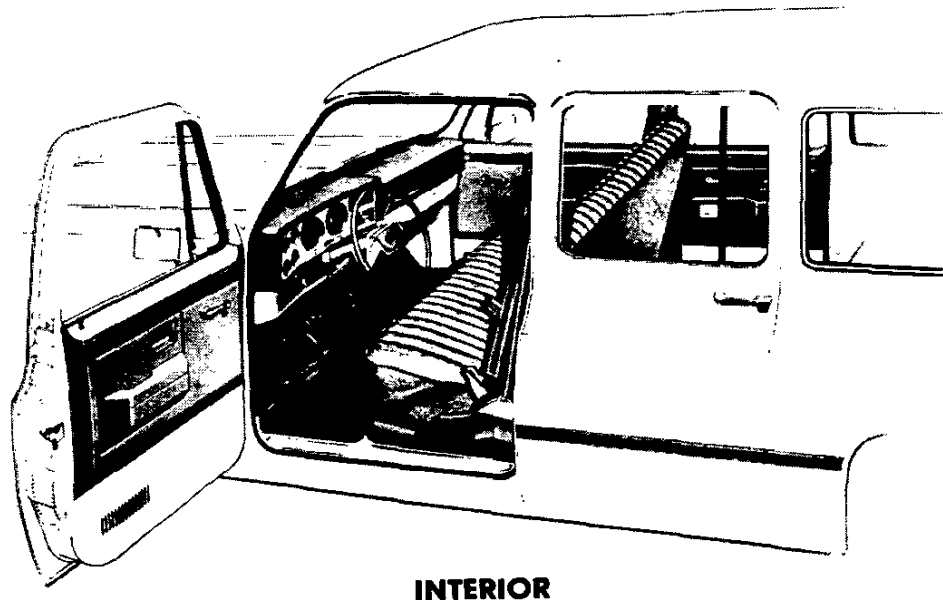

INTERIOR

• **Bright Appearance Items:**

- "Scottsdale/High Sierra" nameplate on instrument panel pad
- Trim on instrument cluster bezel and instrument panel pad applique
- **Cigar Lighter:** With fiber optic illuminated ashtray
- **Dome Lamps:** Two; one front, one rear
- **Dome and Interior Lamp Switches:** Front side door actuated (dome and interior lamps also may be activated by main light switch)
- **Floor Covering:** Color-keyed rubber mat in front seat area (also in center and rear seat areas when optional center seat is ordered)
- **Headliner:** Full-length, color-keyed, perforated molded plastic

with fiberglass blanket backing; includes matching retainer moldings

- **Insulation:** Under cowl panel and on back of headliner
- **Pillar Trim Panels:** Color-keyed molded plastic on windshield pillars and center door pillars
- **Seats:** Embossed grained all-vinyl trim standard. Also available at extra cost: 1) textured velour cloth/vinyl trim; or 2) all-vinyl pigskin grained trim. See Interior and Exterior Color Selection Chart for color and trim availability
- **Sill Plates:** Full-length bright metal for front side doors
- **Spare Tire Cover:** Color-keyed carpet
- **Sunshades:** Mystic colored to match headliner

C/K SUBURBAN SILVERADO/SIERRA CLASSIC MODEL OPTION—RPO YE9

This option includes all items in the Scottsdale model option plus the additions or substitutions listed below



GMC model shown (Chevrolet model available)

EXTERIOR

- **Bright Appearance Items:** "Silverado/Sierra Classic" nameplates, with series designation, on front fenders
Chrome-trimmed grille and headlamp bezels (Chevrolet models only)
Body side and rear door (or tailgate) moldings with black paint trim
- **Bright wheel opening lip moldings**
- **Body-to-Fender Insulators**
- **Grille and Headlamp Bezel Paint:** Dark argent (Chevrolet); argent/dark argent (GMC)
- **Hood Insulator**
- **Special Headlamps:** Rectangular; dual RH and LH

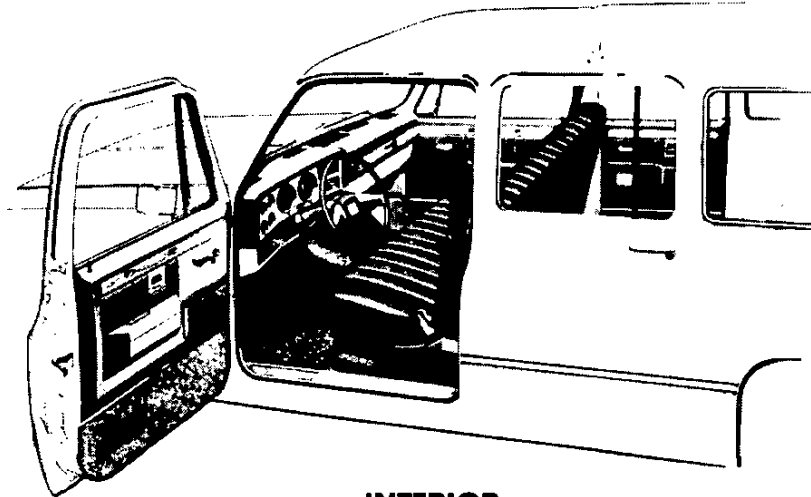

INTERIOR

- **Bright Appearance Items:** "Silverado/Sierra Classic" nameplate on instrument panel pad
MM4 four-speed transmission shift lever (C1-2 models only)
Trim on side door trim panels, and on horn button
- **Cowl Panel Trim:** Color-keyed molded plastic on entire surface of cowl side panels
- **Floor Covering:** Color-keyed carpeting; front seat area (also in center and rear seat areas and on wheelhousings)
- **Garnish Moldings:** Color-keyed molded plastic for body sides (in side rear window areas), lower rear lock pillars, and upper rear doors
- **Headliner:** Full length, color-keyed, foam backed cloth; includes matching retainer moldings
- **Instrument Cluster:** Voltmeter, engine temperature gage, and oil pressure gage replace warning lights; includes pewter-toned brush-finished bezel
- **Instrument Panel Pad Applique:** Pewter-toned brushed finish with bright, black, and silver trim
- **Insulation:** Extra-thick front compartment floor insulators, including full-width insulator under front seat (also in center and rear seat areas when optional center seat is ordered), on back of headliner, and on body side trim panels
- **Seats:** Choice of: 1) all-vinyl pigskin grained trim; or 2) textured velour cloth/vinyl trim. Also available at extra cost: High back bucket seats are available in Custom Vinyl or Custom Cloth (includes console). See Interior and Exterior Color Selection Chart for color and trim availability
- **Trim Panels:** Color-keyed molded plastic door trim panels (with door closing assist strap and vinyl stowage pockets; on front door units only); includes pewter-toned brush-finished upper decorative inserts having bright, black, and silver borders, cloth inserts in armrest area plus carpeting on lower portions. Vinyl-covered color-keyed molded plastic body side trim panels (in rear quarter areas) with carpet trim. Vinyl-covered color-keyed hardboard lower rear door trim panels with carpet trim. (Color-keyed molded plastic tailgate trim panel with carpet trim for models with optional tailgate)
- **Steering Wheel:** Bright trim on horn button
- **Visor Mirror:** On RH sun visor

C/K SUBURBAN REAR DOOR TYPES

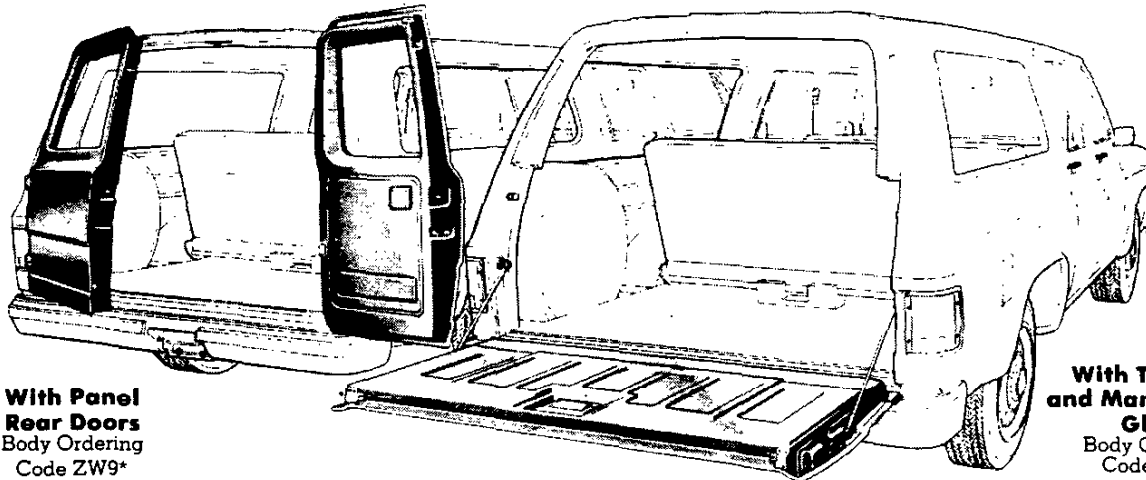

**With Panel
Rear Doors**
Body Ordering
Code ZW9*

**With Tailgate
and Manual Drop
Glass**
Body Ordering
Code E55*

Suburban models have 4 side doors, two front and two rear. Front side doors are equipped with drop-glass and ventipane assemblies; the rear side doors have a drop-glass in the forward portion and fixed glass in the rear portion. The rear quarter windows have fixed glass.

All Suburbans ordered with Body Ordering Code ZW9 have panel-type rear doors incorporating fixed glass, positive fork-cam latches, and an outside key lock. A 2-position, strap-type check on each door permits either a 118- or 162-degree door opening, depending on how the retaining pin is positioned; full door opening of 172-degrees is obtained by removing the retaining pin.

Suburbans ordered with Body Ordering Code E55 have a tailgate with a manually-controlled curved drop glass. Operation of the window is through an articulated crank-type regulator handle on the tailgate outer panel; a key lock cylinder is concealed in the regulator handle, and must be unlocked before the window can be lowered. After the window is lowered, the tailgate can be lowered by moving the release handle at the upper center of the tailgate inner panel. When the tailgate is open, it is supported by reel-type cables. Embossments on the tailgate inner panel facilitate loading of large objects. An optional electric tailgate window is available by ordering RPO A33.

*Both models shown with optional folding center and removable rear seats

CUSTOM OPTIONS

Chromed Bumpers with Rub Strips (RPO VE5)

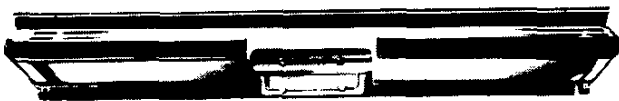

Chromed bumpers with rub strips are available optionally on all Suburban models.

Custom Trim Moldings (RPO B84, B96, YG1)

Body side and rear trim moldings (RPO B84) are black plastic with bright trim and are available for standard Suburban models. They are included in the Custom Molding Package (RPO YG1) for standard and Scottsdale/High Sierra models which also includes bright wheel opening moldings with black paint trim (RPO B96) and bright trim for front side marker lamps and taillamps.

(RPO B85, B96, YG3)

Bright plastic body side and rear moldings with black paint trim (RPO B85) are available for standard and Scottsdale/High Sierra Suburban models. They are included in the Deluxe Molding Package (RPO YG3) which also includes the wheel opening moldings (RPO B96) and other bright lamp trim items described above for RPO YG1.

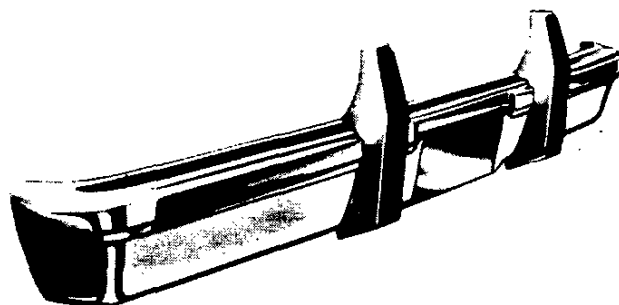

Chromed Front Bumper Guards (RPO V31)

Chromed front bumper guards with rub strips are available optionally on Suburban models. Not available when chromed bumpers with rub strips are ordered.

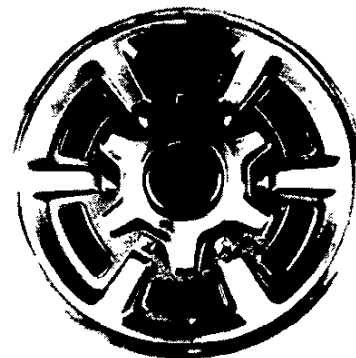

Wheel Covers

Stainless steel wheel covers are available on all Suburban models. The front units for K10/1500-20/2500 models with 4WD have a cut-out at the center to clear the axle hubs.

C/K SUBURBAN

DIMENSIONS

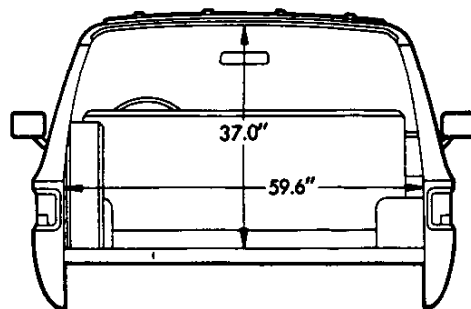
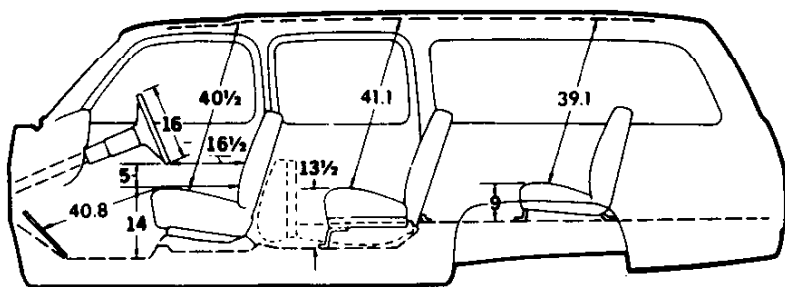

GLASS AREA (Sq. in.)

Windshield 1447	Side rear window (each side) . . . 1074
Front side door, including ventipane (each side) 546	Rear: ZW9 panel doors (total) 654
Rear side door (each side) 488	E55 tailgate 1041

SEATING ARRANGEMENTS

Front Seat
Standard full-depth foam front seat

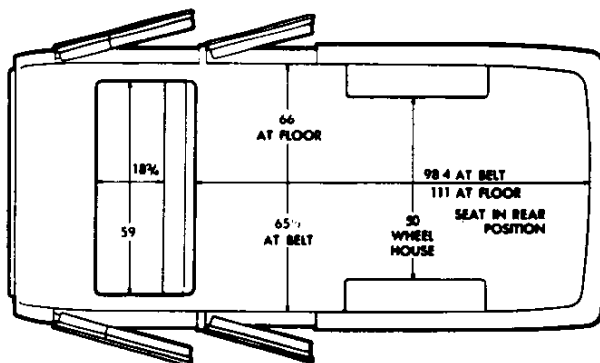

Front and Folding Center Seats
Standard front and RPO AT5 folding center seats

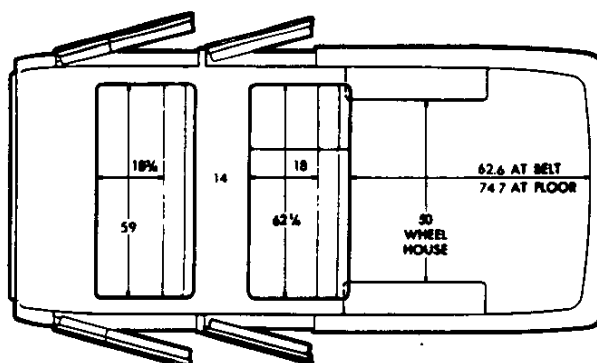

Front and Folding Center Seats
Standard front and RPO AT5 folding center seats
(Center seats shown in folded position)

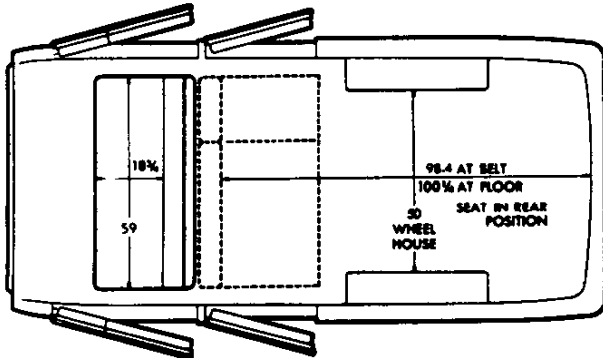

Front, Folding Center and Rear Removable Seats
Standard front, RPO AT5 folding center and
RPO AS3 removable rear seats

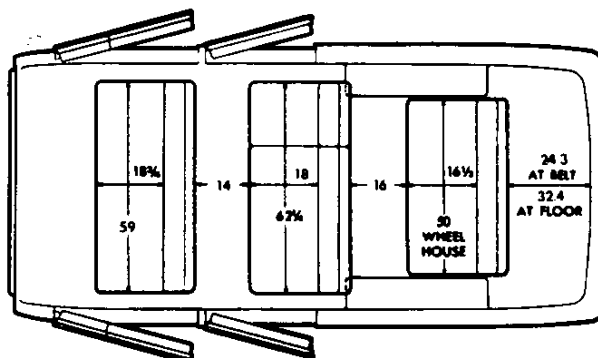

C/K SUBURBAN INTERIOR AND EXTERIOR COLOR AVAILABILITY CHART

Please Note: Below are the interior trim color and exterior paint combinations recommended by Chevrolet/GMC. The only available primary/secondary exterior color combinations are those shown in the chart below, however, any available interior trim color may be ordered with one of these exterior color combinations if that particular combination is desired by the customer.

INTERIOR COLORS	Decor	Blue	Burgundy	Saddle Tan	Slate Grey
CUSTOM DELUXE/SIERRA Vinyl Bench Seat	Std	VDD1		VSS1	
SCOTTSDALE/HIGH SIERRA Vinyl Bench Seat	Z62	VDD1		VSS1	
Custom Vinyl Bench Seat		XDD1		XSS1	
Custom Cloth Bench Seat		LDD1		LSS1	
SILVERADO/SIERRA CLASSIC Custom Vinyl Bench Seat	YE9	XDD1	XEE1	XSS1	
Custom Cloth Bench Seat		LDD1	LEE1	LSS1	LTT1
Custom Vinyl Reclining Bucket		XDD6		XSS6	
Custom Cloth Reclining Bucket		LDD6		LSS6	LTT6

EXTERIOR COLORS w/ZY1 or ZY3 PAINT	Primary	Secondary	RECOMMENDED INTERIOR TRIM COLOR			
BLACK, MIDNIGHT	19	19		X	X	X
Silver (Metallic)	19	17				X
Tan, Doeskin	19	61			X	
White, Frost	19	12				X
BLUE, LIGHT (Metallic)	21	21	X			X
Blue, Midnight	21	29	X			
Silver (Metallic)	21	17	X			X
White, Frost	21	12	X			
BLUE, MIDNIGHT	29	29	X			X
Blue, Light (Metallic)	29	21	X			
Silver (Metallic)	29	17	X			X
White, Frost	29	12	X			
BRONZE, INDIAN (Metallic)	66	66			X	
Tan, Doeskin	66	61			X	
White, Frost	66	12			X	
RED, APPLE	72	72		X	X	
Silver (Metallic)	72	17		X		
Tan, Doeskin	72	61		X		
White, Frost	72	12		X		
SAND, DESERT (Metallic)	64	64			X	
Black, Midnight	64	19			X	
Tan, Doeskin	64	61			X	
White, Frost	64	12			X	
SILVER (Metallic)	17	17	X	X		X
Black, Midnight	17	19				X
Blue, Light (Metallic)	17	21	X			
Blue, Midnight	17	29	X			
Red, Apple	17	72				X
White, Frost	17	12				X
TAN, DOESKIN	61	61			X	
Black, Midnight	61	19			X	
White, Frost	61	12			X	
WHITE, FROST	12	12	X	X	X	X
Black, Midnight	12	19		X		X
Blue, Light (Metallic)	12	21	X			
Blue, Midnight	12	29	X			
Red, Apple	12	72		X		
Silver (Metallic)	12	17				X
Tan, Doeskin	12	61			X	
YELLOW, COLONIAL	53	53			X	
Black, Midnight	53	19			X	
Tan, Doeskin	53	61			X	
White, Frost	53	12			X	

w/ZY5 PAINT (Interior and Exterior Combinations Shown are the Only Combinations Available)	Primary	Secondary	STRIPE COLOR			
BLACK, MIDNIGHT/Red, Apple	19	72		X		Vermillion/Black
BLACK, MIDNIGHT/Silver (Metallic)	19	17				Vermillion/Black
BLACK, MIDNIGHT/Tan, Doeskin	19	61			X	Vermillion/Black
BLACK, MIDNIGHT/White, Frost	19	12				Vermillion/Black
BLUE, LIGHT (Metallic)/Blue, Midnight	21	29	X			Light Blue/Dark Blue
BLUE, LIGHT (Metallic)/Silver (Metallic)	21	17	X			Dark Blue/Light Slate
BLUE, LIGHT (Metallic)/White, Frost	21	12	X			Dark Blue/White
BLUE, MIDNIGHT/Blue, Light (Metallic)	29	21	X			Light Blue/Dark Blue
BLUE, MIDNIGHT/Silver (Metallic)	29	17	X			Vermillion/Light Slate
BRONZE, INDIAN (Metallic)/Tan, Doeskin	66	61			X	Almond/Dark Brown
BRONZE, INDIAN (Metallic)/White, Frost	66	12			X	Almond/Dark Brown
RED, APPLE/Black, Midnight	72	19		X		Vermillion/Black
RED, APPLE/Silver (Metallic)	72	17		X		Vermillion/Dark Carmine
RED, APPLE/Tan, Doeskin	72	61		X	X	Vermillion/Black
RED, APPLE/White, Frost	72	12		X		Vermillion/Black
SILVER (Metallic)/Black, Midnight	17	19				Vermillion/Black
SILVER (Metallic)/Blue, Light (Metallic)	17	21	X			Dark Blue/Light Blue
SILVER (Metallic)/Blue, Midnight	17	29	X			Light Blue/Dark Blue
SILVER (Metallic)/Red, Apple	17	72				Vermillion/Black
TAN, DOESKIN/Black, Midnight	61	19			X	Vermillion/Dark Carmine
TAN, DOESKIN/Red, Apple	61	72			X	Vermillion/Black
YELLOW, COLONIAL/Tan, Doeskin	53	61			X	Almond/Dark Brown
YELLOW, COLONIAL/White, Frost	53	12			X	Almond/Dark Brown

C/K SUBURBAN

SOLID AND TWO-TONE* EXTERIOR COLOR COMBINATIONS

The application of paint for solid and two-tone exterior color combinations is shown below.

Solid color paint (ZY1) is standard on all models. All painted areas of the body and front end sheet metal are the same color.

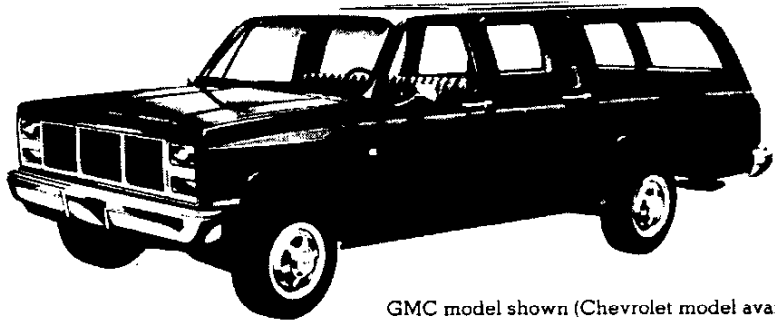

GMC model shown (Chevrolet model available)



Chevrolet model shown (GMC model available)

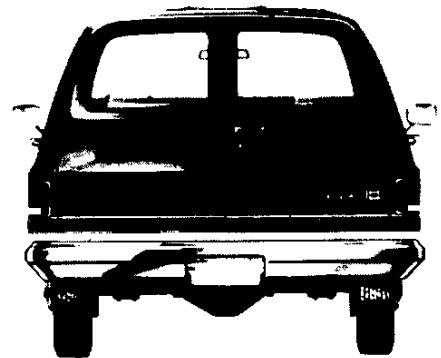

Special two-tone (ZY3) paint colors include the YG1 molding package consisting of black vinyl body side and rear moldings with bright trim, bright wheel opening moldings, and bright trim for front side marker lights and tail lights (except with the YG3 molding package or the Silverado/

Sierra Classic Model Option where bright body side and rear moldings with black paint trim are substituted). The primary color is applied to the areas above the moldings (including the roof). The secondary color is applied to the areas below the moldings.



GMC model shown (Chevrolet model available)

Exterior Decor Package (ZY5) paint colors and trim are available (see Interior and Exterior Color Availability Chart). The package includes the moldings described under Special Two-Tone. In addition, it includes dual-tone body side and rear tape decal striping keyed to the exterior body color. This striping is applied to the front fenders, side doors and body sides and rear a few inches above the styling crease line. The areas above the striping and below the molding are painted the primary paint color. The secondary color is used between the striping and the molding. A bright spring-loaded, stand-up type hood ornament is included on gasoline engine models.

*Optional at extra cost.

NOTES



AVANTI

1984

Suburban.

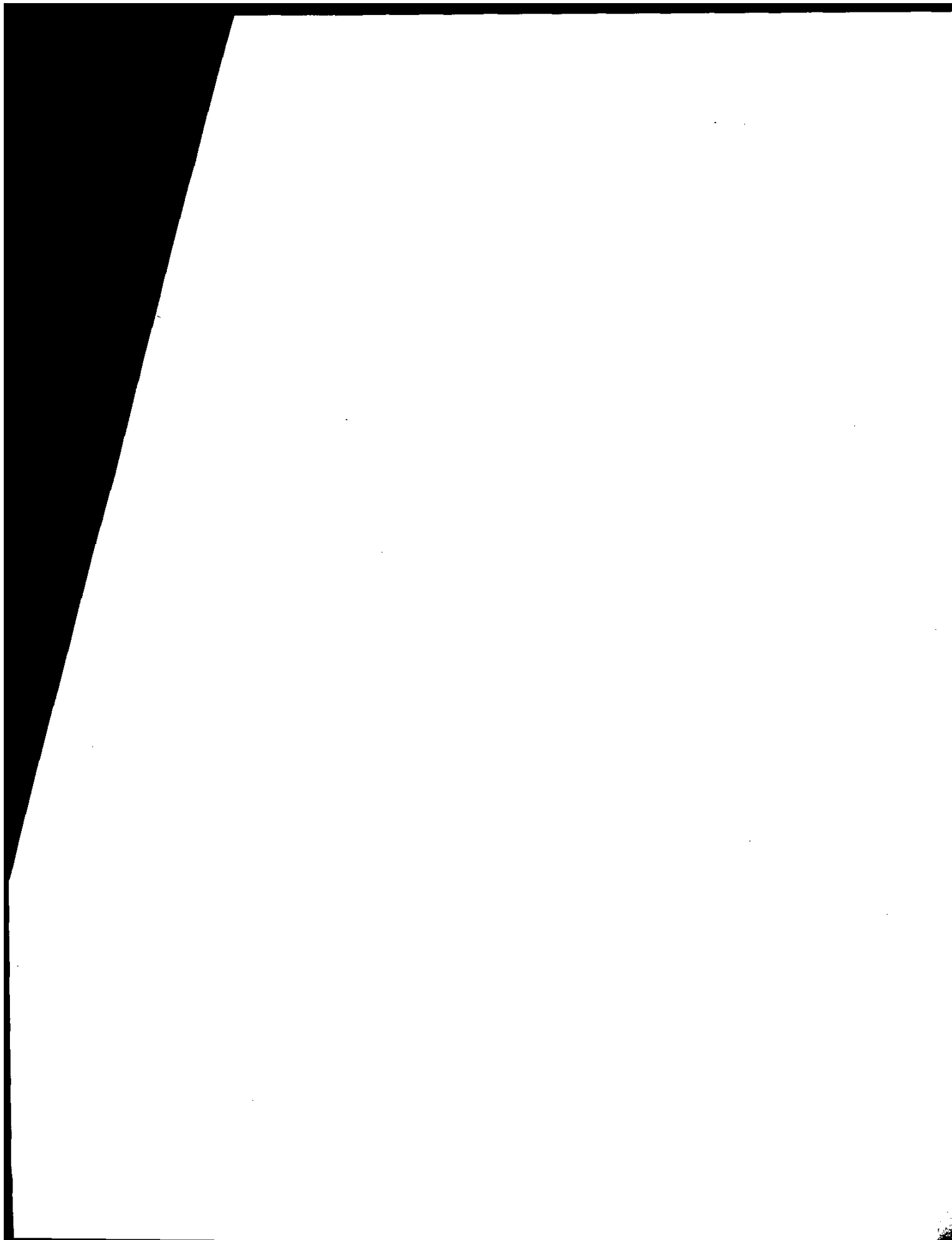

O R I G I N A L
C/K SUBURBAN
 1 9 8 6
SUBURBAN MODEL SELECTOR

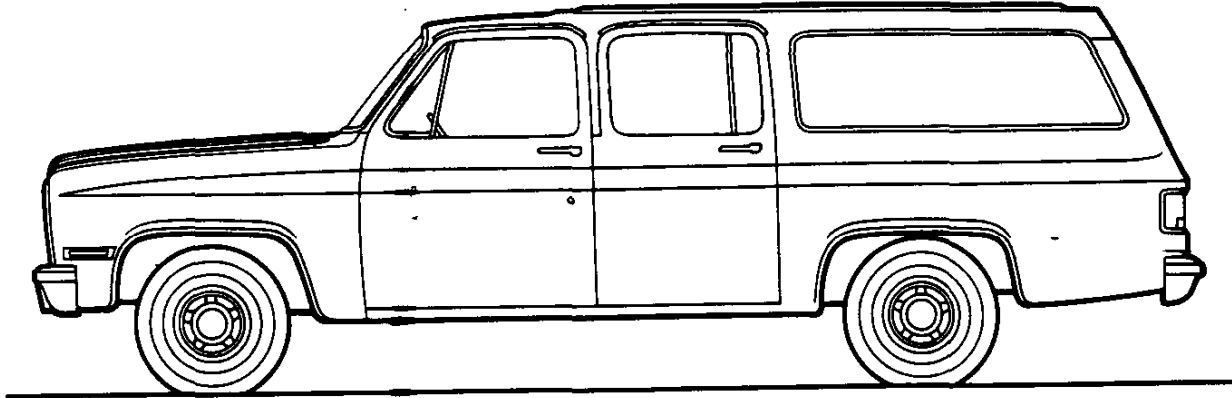

SERIES	MODEL NUMBER	BODY ORDERING CODE			
		GASOLINE MODELS		DIESEL MODELS	
		PANEL REAR DOORS	TAILGATE	PANEL REAR DOORS	TAILGATE
C10/1500	C10906	ZW9	E55	ZW9/B3J	E55/B3J
C20/2500	C20906	ZW9	E55	ZW9/B3J	E55/B3J
K10/1500 (4X4)	K10906	ZW9	E55	ZW9/B3J	E55/B3J
K20/2500 (4X4)	K20906	ZW9	E55	ZW9/B3J	E55/B3J

GASOLINE

C/K SUBURBAN—2-Wheel Drive

STANDARD SPECIFICATIONS

(See Gray Tab Section for Specification Details)

Series	C10/1500	C20/2500
Engine		
Base Equip.	■5.0 Liter, 305 4-bbl V8	5.7 Liter, 350 4-bbl. V8
Clutch	—	12", 150 sq. in.
Air Filter	Oiled-paper Element	
Oil Filter	Throwaway Type	
Exhaust System	*Single; Aluminized	**Dual; Stainless Steel
Emission Control Systems	See Engine & Cooling Section for specific model applications	
Suspension, Front	Independent; Coil Springs	
Capacity	3250 lb.	3800 lb.
Springs @ Ground	1625 lb. ea.	1900 lb. ea.
Shock Absorbers	25mm dia.	32mm dia.
Stabilizer Bar	—	1.06" dia.
Suspension, Rear	Salisbury Axle; Hypoid Drive; Two-stage Multi-leaf Springs	
Axle Capacity	4000 lb.	6000 lb.
Axle Ratio	3.08	3.42
Springs @ Ground	2000 lb. ea.	3000 lb. ea.
Shock Absorbers	25mm dia.	32mm dia.
Brakes	Hydraulic; Self-adjusting	
Front	Disc; 11.86" Rotor	Disc; 12.5" Rotor
Rear	Drum; 11.15" x 2.75"	Drum; 13.0" x 2.5"
Booster	Dual Diaphragm	
Parking	Cable to Rear Wheels	
Electrical	12 Volt; Negative Ground	
Battery—Freedom Type	405 CCA♦ @ 0°F.	
—Reserve Capacity	75 min. @ 80°F.	
Delcotron Generator	37 amp.	
Frame	Carbon Steel; 36,39,000 psi	
Section Modulus	3.10	3.88
Fuel Tank (nominal capacity)	25 gal.	
Steering Gear Type	Manual; Recirculating Ball Gear	
Linkage	Parallelogram	
Transmission	4-Speed Automatic w/Overdrive	4-Speed Manual (SM 465)
Shift Location	Steering Column	Floor
Tires	(5) P235/75R15 All Seasons Steel Belted Radial	Fr. (2) LT235/85R16D (8PR) Rr. (2) LT235/85R16E (10PR)
Wheels	(5) Disc 15" x 6"	(4) Disc 16" x 6.5"

■Standard engine not available for registration in the State of California; see Power Teams chart.

*Dual tail pipe

**Single; Aluminized for California

♦CCA-Cold Cranking Amps

C/K SUBURBAN—2-Wheel Drive

DIESEL

STANDARD SPECIFICATIONS

(See Gray Tab Section for Specification Details)

Series	★C10/1500	C20/2500
Engine	6.2 Liter, 379 Cu. In. V8 Diesel	
Base Equip.	Poly-wrapped, Oiled-paper Element	
Air Filter	Throwaway Type	
Oil Filter	Standard	
Oil Cooler	Dual; Aluminized	
Exhaust System	See Engine & Cooling Section for specific model applications	
Emission Control Systems		
Suspension, Front	Independent; Coil Springs	
Capacity	3400 lb.	3800 lb.
Springs @ Ground	1700 lb. ea.	1900 lb. ea.
Shock Absorbers	25mm dia.	32mm dia.
Stabilizer Bar	1.06" dia.	
Suspension, Rear	Salisbury Axle; Hypoid Drive; Two-stage Multi-leaf Springs	
Axle Capacity	4000 lb.	6000 lb.
Axle Ratio	3.08	3.73
Springs @ Ground	2000 lb. ea.	3000 lb. ea.
Shock Absorbers	25mm dia.	32mm dia.
Brakes	Hydraulic; Self-adjusting	
Front	Disc; 11.86" Rotor	Disc; 12.5" Rotor
Rear	Drum; 11.15" x 2.75"	Drum; 13.0" x 2.5"
Booster	Hydraulic Power	
Parking	Cable to Rear Wheels	
Electrical	12 Volt; Negative Ground	
Battery—Freedom Type	Two; 500 CCA♦ ea. @ 0°F.	
—Reserve Capacity	115 min. ea. @ 80°F.	
Delcotron Generator	66 amp.	
Engine Block Heater	600 watts, 120 volts	
Frame	Carbon Steel; 36,39,000 psi	
Section Modulus	3.10	3.88
Fuel Tank (nominal capacity)	27 gal.	
Steering Gear Type	Integral Power	
Transmission	4-Speed Automatic w/Overdrive	3-Speed Automatic
Shift Location	Steering Column	
Tires	(5) P235/75R15 XL All Seasons Steel Belted Radial	Fr. (2) LT235/85R16D (8PR) Rr. (2) LT235/85R16E (10PR)
Wheels	(5) Disc 15" x 6"	(4) Disc 16" x 6.5"

★Not available for registration in State of California

♦CCA-Cold Cranking Amps

GASOLINE

C/K SUBURBAN—4-Wheel Drive

STANDARD SPECIFICATIONS

(See Gray Tab Section for Specification Details)

Series	K10/1500	K20/2500
Engine	5.7 Liter, 350 4-bbl. V8	
Base Equip.	12"; 150 sq. in.	
Clutch	Oiled-paper Element	
Air Filter	Throwaway Type	
Oil Filter	*Single; Aluminized	**Dual; Stainless Steel
Exhaust System	See Engine & Cooling Section for specific model applications	
Emission Control Systems		
Suspension, Front	Salisbury Axle, Hypoid Drive; Single-stage 2-leaf Springs	
Capacity	3600 lb.	3800 lb.
Axle Ratio	3.42	3.42
Springs @ Ground	1850 lb. ea.	1850 lb. ea.
Shock Absorbers	25mm dia.	32mm dia.
Stabilizer Bar	1.25" dia.	1.25" dia.
Hubs, Manual Locking	Standard	Standard
Suspension, Rear	Salisbury Axle, Hypoid Drive; Two-stage Multi-leaf Springs	
Axle Capacity	4000 lb.	6000 lb.
Axle Ratio	3.42	3.42
Springs @ Ground	2000 lb. ea.	3000 lb. ea.
Shock Absorbers	25mm dia.	32mm dia.
Brakes	Hydraulic; Self-adjusting	
Front	Disc; 11.86" Rotor	Disc; 12.5" Rotor
Rear	Drum; 11.15" x 2.75"	Drum; 13" x 2.5"
Booster	Dual Diaphragm	
Parking	Cable to Rear Wheels	
Electrical	12 Volt; Negative Ground	
Battery - Freedom Type	405 CCA ♦ @ 0°F.	
- Reserve Capacity	75 min. @ 80°F.	
Delcotron Generator	37 amp.	
Frame	Carbon Steel; 36, -39,000 psi	
Section Modulus	3.57	3.88
Fuel Tank (nominal capacity)	25 gal.	
Steering Gear Type	Integral Power	
Transmission	4-Speed Manual (SM 465)	
Shift Location	Floor	
Transfer Case	New Process 208 2-Speed	
Shift Lever	Single Lever	
Tires	(5) P215/75R15 All Seasons Steel Belted Radial	Fr. (2) LT235/85R16D (8PR) Rr. (2) LT235/85R16E (10PR)
Wheels	(5) Disc 15" x 6"	(4) Disc 16" x 6.5"

*Dual tail pipe on K10/1500 model.

**Single, Aluminized for California.

♦CCA-Cold Cranking Amps.

C/K SUBURBAN—4-Wheel Drive

DIESEL

STANDARD SPECIFICATIONS

(See Gray Tab Section for Specification Details)

Series	★K10/1500	K20/2500
Engine	6.2 Liter, 379 Cu. In. V8 Diesel	
Base Equip.	Poly-wrapped, Oiled-paper Element	
Air Filter	Throwaway Type	
Oil Filter	Standard	
Oil Cooler	Dual; Aluminized	
Exhaust System	See Engine & Cooling Section for specific model applications	
Emission Control System		
Suspension, Front	Salisbury Axle, Hypoid Drive; Single-stage 2-leaf Springs	
Capacity	3600 lb.	3800 lb.
Axle Ratio	3.42	3.73
Springs @ Ground	1850 lb. ea.	1850 lb. ea.
Shock Absorbers	25mm dia.	32mm dia.
Stabilizer Bar	1.25" dia.	1.25" dia.
Hubs, Manual Locking	Standard	Standard
Suspension, Rear	Salisbury Axle, Hypoid Drive; Two-stage Multi-leaf Springs	
Axle Capacity	4000 lb.	6000 lb.
Axle Ratio	3.42	3.73
Springs @ Ground	2000 lb. ea.	3000 lb. ea.
Shock Absorbers	25mm dia.	32mm dia.
Brakes	Hydraulic; Self-adjusting	
Front	Disc; 11.86" Rotor	Disc; 12.5" Rotor
Rear	Drum; 11.15" x 2.75"	Drum; 13" x 2.5"
Booster	Hydraulic Power	
Parking	Cable to Rear Wheels	
Electrical	12 Volt; Negative Ground	
Battery—Freedom Type	Two; 550 CCA ♦ ea. @ 0° F.	
—Reserve Capacity	115 min. ea. @ 80° F.	
Delcotron Generator	66 amp.	
Engine Block Heater	600 watts, 120 volts	
Frame	Carbon Steel; 36,-39,000 psi	
Section Modulus	3.57	3.88
Fuel Tank (nominal capacity)	27 gal.	
Steering Gear Type	Integral Power	
Transmission	4-Speed Automatic w/Overdrive	3-Speed Automatic
Shift Location	Steering Column	
Transfer Case	New Process 208 2-Speed	
Shift Lever	Single Lever	
Tires	(5) P235/75R15 All Seasons Steel Belted Radial	Fr. (2) LT235/85R16D (8PR) Rr. (2) LT235/85R16E (10PR)
Wheels	(5) Disc 15" x 6"	(4) Disc 16" x 6.5"

★ Not available for registration in State of California

♦ CCA-Cold Cranking Amps.

GASOLINE

C/K SUBURBAN

**Body Ordering Codes:
Panel Rear Doors—ZW9
Endgate—E55†**

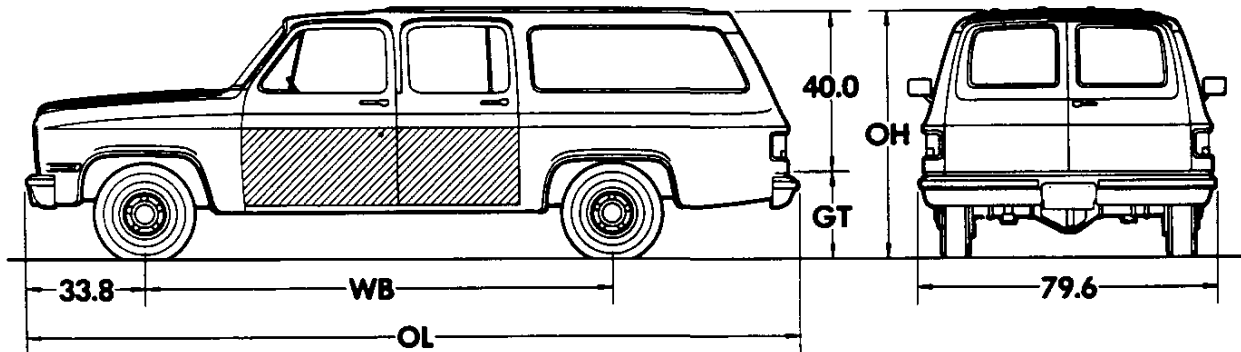

Capacity— 165 cu ft
Load Floor Area— 40 sq ft

Sign Panel Area (side)
22" x 72¼"

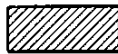

Series	Ground Clearance (in)*	
	Front	Rear
C1	6.6	6.7
C2	8.5	8.5
K1	6.9	7.1
K2	8.6	8.6

Model	Engine No. Cyl.	Dimensions (in)*				†Curb Weight (lb)			†Model Weight (lb)*		
		WB	OL	OH	GT	Front	Rear	Total	Front	Rear	Total

C10/1500 SERIES

C10906	8	129.5	219.1	72.0	29.0	2009	2270	4279	2352	2377	4729
---------------	---	-------	-------	------	------	------	------	------	------	------	------

C20/2500 SERIES

C20906	8	129.5	219.1	74.3	31.7	2349	2422	4771	2592	2629	5221
---------------	---	-------	-------	------	------	------	------	------	------	------	------

K10/1500 SERIES

K10906	8	129.5	219.1	73.8	30.1	2469	2217	4686	2712	2424	5136
---------------	---	-------	-------	------	------	------	------	------	------	------	------

K20/2500 SERIES

K20906	8	129.5	219.1	76.1	33.6	2608	2450	5058	2851	2657	5508
---------------	---	-------	-------	------	------	------	------	------	------	------	------

*Dimensions with standard equipment, unloaded.

*Model Weight includes Curb Weight plus occupants (standard seating capacity x 150 lb). Total Model Weight may vary as much as ±50 lbs. to allow for production build variation.

†Curb Weights and Model Weights shown are for models with ZW9 Panel Rear Doors. For models with E55 Endgate, weights must be adjusted as follows: Front -7 lb.; Rear +41 lb.; Total added weight 34 lb.

C/K SUBURBAN

DIESEL

Body Ordering Codes:
Panel Rear Doors—ZW9/B3J
Endgate—E55/B3J†

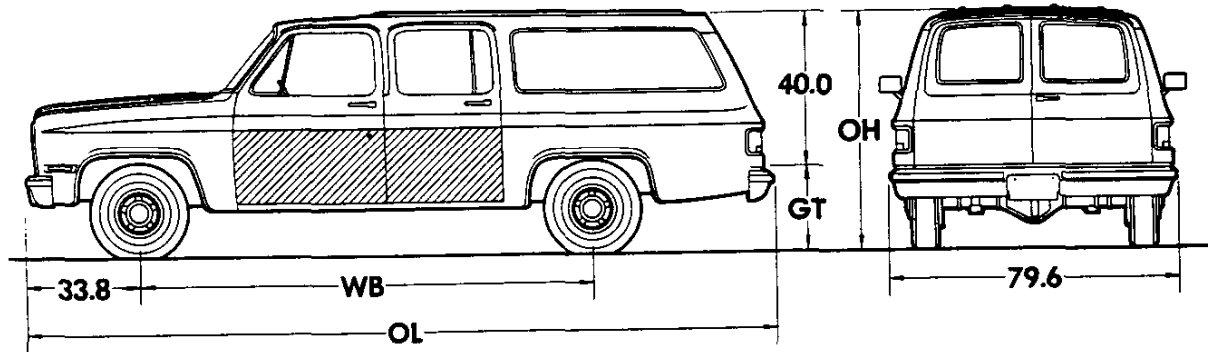

Capacity—165 cu ft
Load Floor Area—40 sq ft

Sign Panel Area (side)
 22" x 72¼"

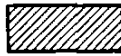

Series	Ground Clearance (in)*	
	Front	Rear
C1	6.6	6.7
C2	8.5	8.5
K1	6.9	7.1
K2	8.6	8.6

Model	Engine No. Cyl.	Dimensions (in)*				†Curb Weight (lb)			†Model Weight (lb)*		
		WB	OL	OH	GT	Front	Rear	Total	Front	Rear	Total
C10/1500 SERIES											
C10906	8	129.5	219.1	72.0	29.0	2363	2349	4712	2706	2456	5162
C20/2500 SERIES											
C20906	8	129.5	219.1	74.3	31.7	2691	2538	5229	2934	2745	5679
K10/1500 SERIES											
K10906	8	129.5	219.1	73.8	30.1	2773	2321	5094	3016	2528	5544
K20/2500 SERIES											
K20906	8	129.5	219.1	76.1	33.6	2955	2577	5532	3198	2784	5982

*Dimensions with standard equipment, unloaded.

*Model Weight includes Curb Weight plus occupants (standard seating capacity x 150 lb). Total Model Weight may vary as much as ±50 lbs. to allow for production build variation.

†Curb Weights and Model Weights shown are for models with ZW9 Panel Rear Doors. For models with E55 Endgate, weights must be adjusted as follows: Front -7 lb.; Rear +41 lb.; Total added weight 34 lb.

C/K SUBURBAN

POWER TEAMS

ALL STATES EXCEPT CALIFORNIA

POWER TEAMS (MUST ORDER ENGINE, TRANSMISSION AND REAR AXLE)

(Consult GVWR Selector and Tire Chart to insure tire capacity and availability)

ENGINE	TRANSMISSION		AXLES				GVWR
	4-SP	AUTO	2.73	3.08	3.42	3.73	
W/NA6 STANDARD EMISSION EQUIPMENT							
-C10906							
LE9 V8 5.0 Liter (305-4BBL)		MXO	—	GQ1	GU6	—	61/6800
LS9 V8 5.7 Liter (350-4BBL)		MXO	GQ1	GU4	—	#GT4	6100
		MXO	—	GQ1	GU6	#GT4	6800
LH6 Diesel 6.2 Liter V8 (379 Cu In)(Reqs B3J)		MXO	—	GQ1	GU6	#GT4	7000
-K10906							
LS9 V8 5.7 Liter (350-4BBL)	MM4		—	—	GQ1	GT4	61/7000
		MXO	—	—	GQ1	#GT4	61/7000
LH6 Diesel 6.2 Liter V8 (379 Cu In)(Reqs B3J)		MXO	—	—	GQ1	GT4	70/7300
W/NA6 HIGH ALTITUDE EMISSION EQUIPMENT							
-C10906							
LE9 V8 5.0 Liter (305-4BBL)		MXO	—	GQ1	GU6	—	61/6800
LS9 V8 5.7 Liter (350-4BBL)		MXO	—	—	GQ1	GT4	61/6800
LH6 Diesel 6.2 Liter V8 (379 Cu In)(Reqs B3J)		MXO	—	—	GQ1	GT4	7000
-K10906							
LS9 V8 5.7 Liter (350-4 BBL)	MM4		—	—	GQ1	GT4	61/7000
		MXO	—	—	GQ1	GT4	61/7000
LH6 Diesel 6.2 Liter V8 (379 Cu In)(Reqs B3J)		MXO	—	—	GQ1	GT4	70/7300

#Reqs Z82 Trailering Special

CALIFORNIA ONLY

POWER TEAMS (MUST ORDER ENGINE, TRANSMISSION AND REAR AXLE)

(Consult GVWR Selector and Tire Chart to insure tire capacity and availability)

ENGINE	TRANSMISSION		AXLES				GVWR
	4-SP	AUTO	2.73	3.08	3.42	3.73	
W/YF5 CALIFORNIA EMISSION REQUIREMENTS							
-C10906							
LS9 V8 5.7 Liter (350-4 BBL)		MXO	—	GQ1	GU6	—	61/6800
-K10906							
LS9 V8 5.7 Liter (350-4BBL)		MXO	—	—	GQ1	GT4	61/7000

#Reqs Z82 Trailering Special

C/K SUBURBAN

POWER TEAMS

ALL STATES

POWER TEAMS (MUST ORDER ENGINE, TRANSMISSION AND REAR AXLE)
 (Consult GVWR Selector and Tire Chart to insure tire capacity and availability)

W/NA5 STANDARD Satisfies High Altitude Emission Requirements), NA6 HIGH ALTITUDE ■ OR YF5 CALIFORNIA EMISSIONS

ENGINE	TRANSMISSION							GVWR
	4-SP	AUTO	*3.21	3.42	3.73	4.10	4.56	
--C20906								
§§LT9 V8 5.7 Liter (350-4BBL)	MM4		—	GQ1	GT4	GT5	—	8600
		MX1	—	—	GQ1	GT5	HC4	8600
§§LE8 V8 7.4 Liter (454-4BBL) (Reqs N41 and UA1)		MX1	*GQ1	—	GT4	GT5	—	8600
		MX1	—	—	GQ1	GT5	HC4	8600
LL4 Diesel 6.2 Liter V8 (379 Cu In)(Reqs B3J)		MX1	—	—	GQ1	GT5	HC4	8600
--K20906								
§§LT9 V8 5.7 Liter (350-4BBL)	MM4		—	GQ1	GT4	GT5	—	8600
		MX1	—	—	GQ1	GT5	—	8600
LL4 Diesel 6.2 Liter V8 (379 Cu In)(Reqs B3J)		MX1	—	—	GQ1	GT5	—	8600

*N/A G80 Locking Differential

§§N/A NA6 High Altitude Emissions. With NA5 Emissions Satisfies High Altitude Requirements

■ High Altitude Emission Equipment (FOR EXHAUST SMOKE REDUCTION PURPOSES AT HIGH ALTITUDE:
 NOT REQUIRED TO SATISFY HIGH ALTITUDE REGULATIONS)(REQS LL4 ENG)

ENGINE RATINGS

ALL STATES EXCEPT CALIFORNIA

SAE Net Ratings	*5.0 Liter 305 4-bbl V8	*5.7 Liter 350 4-bbl V8	**5.7 Liter 350 4-bbl V8	**7.4 Liter 454 4-bbl V8
Net Horsepower	160 @ 4400 rpm	165 @ 3800 rpm	185 @ 4000 rpm	240 @ 3800 rpm
Net Torque, lb-ft	235 @ 2000 rpm	275 @ 1600 rpm	285 @ 2400 rpm	375 @ 3200 rpm
SAE Net Ratings	*6.2 Liter 379 V8 Diesel		**6.2 Liter 379 V8 Diesel	
Net Horsepower	130 @ 3600 rpm		148 @ 3600 rpm	
Net Torque, lb-ft	240 @ 2000 rpm		246 @ 2000 rpm	

*Engine with Light or Medium Duty Emissions (w/GVWR up to 8500 lb.)

**Engine with Heavy Duty Emissions (w/GVWR over 8500 lb.)

CALIFORNIA ONLY

SAE Net Ratings	*5.7 Liter 350 4-bbl V8	**5.7 Liter 350 4-bbl V8	**7.4 Liter 454 4-bbl V8
Net Horsepower	165 @ 3800 rpm	155 @ 4000 rpm	240 @ 3800 rpm
Net Torque, lb-ft	275 @ 1600 rpm	240 @ 2800 rpm	375 @ 3200 rpm

SAE Net Ratings	**6.2 Liter 379 V8 Diesel
Net Horsepower	148 @ 3600 rpm
Net Torque, lb-ft	246 @ 2000 rpm

*Engine with Light or Medium Duty Emissions (w/GVWR up to 8500 lb.)

**Engine with Heavy Duty Emissions (w/GVWR over 8500 lb.)

C/K SUBURBAN

GVWR SELECTOR—ALL STATES

GVW Rating (lbs)	†GAWR (lbs)		Minimum Equipment Required for GVW Rating		
	Front	Rear	Tire Capacity (lbs ea)		Chassis Equipment
			Front	Rear	

C10/1500 SERIES

▲■6100	3250	3686	1843	1843	Standard
▲■6800	3250	3820	1984	1984	Stabilizer Bar (F59)
◆7000	3400	3820	1984	1984	Standard

K10/1500 SERIES

▲■6100	3166	3166	1583	1583	Standard
●■7000	3600	3686	1843	1843	
◆7300	3600	3968	1984	1984	Center and Rear Seats (AS3)

†GAWR's shown are the maximum for each axle with equipment listed. Other GAWR's are available, and they are determined as the minimum capacity of either axle, springs or tires.

▲Not available on diesel engine models.

● On diesel engine models, not available with Center and Rear Seats (AS3).

■ Center seat (AT5) available on all GVWRs; Center and Rear seats (AS3) available on 6800 or above GVWRs.

◆ Available on diesel engine models only.

FRONT AND REAR TIRE AVAILABILITY CHART—ALL STATES

C-K10/1500 SERIES

Spare tire to match either front or rear tires must be ordered.

K10/1500 models require matching front and rear tread

Description	Capacity (lbs ea)	Highway		On-Off Road		Spare
		Front	Rear	*Front	Rear	
TUBELESS						
#P215/75R15 Steel Belted Radial	1583	XCU	YCU	—	—	ZCU
#P215/75R15 Whitewall Steel Belted Radial	1583	XCV	YCV	—	—	ZCV
P235/75R15 Steel Belted Radial	1843	XFL —	YFL —	— *XES	— YES	ZFL ZES
P235/75R15 Whitewall Steel Belted Radial	1843	XFM	YFM	—	—	ZFM
P235/75R15 XL Steel Belted Radial	1984	XHA	YHA	—	—	ZHA
P235/75R15 Whitewall XL Steel Belted Radial	1984	XHB	YHB	—	—	ZHB

*On-Off road front tires available on K1 models only.

#K1 models only. Not available with Diesel Equipment Package (B3).

C/K SUBURBAN

GVWR SELECTOR—ALL STATES

GVW Rating (lbs)	†GAWR (lbs)		Minimum Equipment Required for GVW Rating		
	Front	Rear	Tire Capacity (lbs ea)		Chassis Equipment
			Front	Rear	

C20/2500 SERIES

8600	3800	6000	2623	3042	Standard
------	------	------	------	------	----------

K20/2500 SERIES

8600	3700	6000	2623	3042	Standard
------	------	------	------	------	----------

†GAWR's shown are the maximum for each axle with equipment listed. Other GAWR's are available, and they are determined as the minimum capacity of either axle, springs or tires.

FRONT AND REAR TIRE AVAILABILITY CHART—ALL STATES

C-K20/2500 SERIES

Spare tire to match either front or rear tires is available at extra cost.
K20/2500 models require matching front and rear tread

Description	Capacity (lbs ea)	Highway		On-Off Road		Spare
		Front	Rear	*Front	Rear	
TUBELESS						
LT235/85R16D Steel Belted Radial	2623	XYM	—	—	—	—
LT235/85R16E Steel Belted Radial	3042	—	YYN	—	— #YYT #YYT	ZYN #ZYT #ZYN
LT235/85R16E Steel Belted Radial	3042	XYN	YYN	— *XYT —	— YYT #YYT	ZYN ZYT #ZYN

*On-Off road front tires available on K2 models only.
#Available on C2 models only.

C/K SUBURBAN

THE FOLLOWING EQUIPMENT IS STANDARD ON DIESEL ENGINE MODELS (ALSO SEE STANDARD SPECIFICATIONS PAGES)

- Low Coolant Sensor
- Poly-wrapped Paper Element Air Cleaner
- Auxiliary Engine Oil Cooler provided with 4.56 ratio rear axle (in addition to cooler in radiator tank)
- Power Steering
- Engine Block Heater
- Water/fuel separator unit which incorporates a water sensor and sending unit, a fuel filter, a fuel heater and water drain capability
- Hydraulic Power-assisted Brakes
- K81 66-amp Generator
- Engine Oil Cooler (located in radiator tank)
- Dual 550 Cold Cranking Amp/115 min. Reserve Capacity Batteries
- HD Radiator
- Dual Exhaust System
- Additional Insulation:
 - Cab-to-fender insulators
 - Fiberglass hood insulator
 - Fiberglass engine compartment firewall insulator
 - Cowl side spray-on deadener
 - Driver compartment dash mat with increased mastic layer
 - Resinated cotton and mastic floor insulation
 - Full cowl interior trim panels with resinated cotton insulation
 - Full-length, foam-backed cloth headliner
- Warning Lights: Glow Plugs, Water-in-fuel (or fuel filter), and Low Coolant
- Diesel Engine Identification:
 - Hood ornament
 - Fender nameplates
 - Rear door or tailgate nameplate
 - “Diesel Fuel Only” filler cap and label

C-K SUBURBAN

1986 VEHICLES WITH STANDARD EQUIPMENT

Prices shown are effective with initial shipments of 1986 model motor vehicles

Description	Model Number	Body Code	Wheel Base	Factory D&H(a)	List Price	Mfr's Suggested Retail Price★	Group Number
◆ 8-Cylinder 5.0 Liter (305 Cu. In.) 4 BBL V8 Gasoline Engine-Engine Ordering Code LE9							
C10 Series 2-Wheel Drive							
Panel Doors	CC10906	ZW9	129.5"	N.A.	11437.00	11437.00	16
Tailgate	CC10906	E55	129.5"	N.A.	11476.00	11476.00	16
◆ 8-Cylinder 5.7 Liter (350 Cu. In.) 4 BBL V8 Gasoline Engine-Engine Ordering Code LS9							
K10 Series 4-Wheel Drive							
Panel Doors	CK10906	ZW9	129.5"	N.A.	12456.00	12456.00	16
Tailgate	CK10906	E55	129.5"	N.A.	12495.00	12495.00	16
◆ 8-Cylinder 5.7 Liter (350 Cu. In.) 4 BBL V8 Gasoline Engine-Engine Ordering Code LT9							
C20 Series 2-Wheel Drive							
Panel Doors	CC20906	ZW9	129.5"	3.76	12254.00	12257.76	16
Tailgate	CC20906	E55	129.5"	3.76	12293.00	12296.76	16
K20 Series 4-Wheel Drive							
Panel Doors	CK20906	ZW9	129.5"	3.76	14057.00	14060.76	16
Tailgate	CK20906	E55	129.5"	3.76	14096.00	14099.76	16
◆ 8-Cylinder 6.2 Liter (379 Cu. In.) L.D. Diesel V8 Engine-Engine Ordering Code LH6							
C10 Series 2-Wheel Drive							
Panel Doors	CC10906	ZW9&B3J	129.5"	N.A.	14109.00	14109.00	16
Tailgate	CC10906	E55&B3J	129.5"	N.A.	14149.00	14149.00	16
K10 Series 4-Wheel Drive							
Panel Doors	CK10906	ZW9&B3J	129.5"	N.A.	15594.00	15594.00	16
Tailgate	CK10906	E55&B3J	129.5"	N.A.	15633.00	15633.00	16
◆ 8-Cylinder 6.2 Liter (379 Cu. In.) H.D Diesel V8 Engine-Engine Ordering Code LL4							
C20 Series 2-Wheel Drive							
Panel Doors	CC20906	ZW9&B3J	129.5"	3.76	14808.00	14811.76	16
Tailgate	CC20906	E55&B3J	129.5"	3.76	14847.00	14850.76	16
K20 Series 4-Wheel Drive							
Panel Doors	CK20906	ZW9&B3J	129.5"	3.76	16355.00	16358.76	16
Tailgate	CK20906	E55&B3J	129.5"	3.76	16394.00	16397.76	16

★ Manufacturer's Suggested Retail Prices do not include applicable destination charges, state and local taxes, license fees, optional equipment or special items or services.

◆ Refer to Dealer Order Guide for California Requirements.

OPTIONS WHEN INSTALLED BY GENERAL MOTORS

Prices shown are effective with initial shipments of 1986 model motor vehicles

Description	Option Number	Factory D&H(a)	List Price	Mfr's Suggested Retail Price◇
Scottsdale/High Sierra: (See Interior and Exterior Color Selection Chart) Not available when YE9 is specified. Includes bright windshield and rear side window moldings, B84 Black Body Side Moldings, turn signal and side marker lamp bezels, bright taillight trim, dual horns, nameplates on front fender and instrument panel, U37 Cigarette Lighter, dome lamp with bright bezels, bright sill plates and special insulation. Also includes spare tire cover when spare tire is specified.				
Without B3J Diesel Equipment. Also includes BB5 Headliner	Z62	N.A.	459.00	459.00
With B3J Diesel Equipment	Z62	N.A.	311.00	311.00

(a) D & H Charges on vehicle and optional equipment include reimbursement to ordering Division for any tax that it has paid, incurred or agreed to pay thereon.

◇ State and local taxes not included.

C-K SUBURBAN

OPTIONS WHEN INSTALLED BY GENERAL MOTORS

Prices shown are effective with initial shipments of 1986 model motor vehicles

Description	Option Number	Factory D&H(a)	List Price	Mfr's Suggested Retail Price ◊
Silverado / Sierra Classic: Available only when custom vinyl or cloth seats are specified. Includes wheel opening moldings, custom steering wheel, YG3 Deluxe Molding Package, bright taillight trim and rear door or tailgate moldings, bright front turn signal and front side marker lamp bezels, fender nameplates, bright windshield and rear side window moldings, carpeting, bright sill plates, plastic door trim panels with storage pockets and bright brushed-finish accents, dual horns, visor mirror, B85 Bright Body Side Moldings, V22 Deluxe Front Appearance, nameplate on instrument panel, U37 Cigarette Lighter, dome lamp with bright bezels, special insulation, pillar trim panels, Z53 Voltmeter, Temperature, and Oil Pressure Gages. Also includes spare tire cover when spare tire is specified.				
Without B3J Diesel Equipment. Also includes BB5 Headliner	YE9	N.A.	1259.00	1259.00
With B3J Diesel Equipment	YE9	N.A.	1111.00	1111.00
Seat Trim: Driver and Passenger. (See Interior and Exterior Color Selection Chart for ordering information)				
V**1 Vinyl Bench Seat. Not available when YE9 is specified	...	NO ADDITIONAL CHARGE		
L**1 Custom Cloth Bench Seat. Available only when Z62 or YE9 is specified.	...			
With Z62	...			
Without AT5 or AS3 Seats	...	N.A.	50.00	50.00
With AT5 Center Seat without AS3 Center and Rear Seats. Includes full floor mats	...	N.A.	120.00	120.00
With AS3 Center and Rear Seats. Includes full floor mats	...	N.A.	170.00	170.00
With YE9	...	NO ADDITIONAL CHARGE		
Without AT5 or AS3 Seats	...			
With AT5 Center Seat without AS3 Center and Rear Seats. Includes full carpeting	...	N.A.	141.00	141.00
With AS3 Center and Rear Seats. Includes full carpeting	...	N.A.	191.00	191.00
X**1 Custom Vinyl Bench Seat. Available only when Z62 or YE9 is specified.	...			
With Z62	...			
Without AT5 or AS3 Seats	...	N.A.	50.00	50.00
With AT5 Center Seat without AS3 Center and Rear Seats. Includes full floor mats	...	N.A.	120.00	120.00
With AS3 Center and Rear Seats. Includes full floor mats	...	N.A.	170.00	170.00
With YE9	...	NO ADDITIONAL CHARGE		
Without AT5 or AS3 Seats	...			
With AT5 Center Seat without AS3 Center and Rear Seats. Includes full carpeting	...	N.A.	141.00	141.00
With AS3 Center and Rear Seats. Includes full carpeting	...	N.A.	191.00	191.00
L**6 Custom Cloth Reclining Bucket Seats. Includes console and folding armrests	...			
Without AT5 or AS3 Seats	...	N.A.	364.00	364.00
With AT5 Center Seat without AS3 Center and Rear Seats. Includes full carpeting	...	N.A.	505.00	505.00
With AS3 Center and Rear Seats. Includes full carpeting	...	N.A.	555.00	555.00
X**6 Custom Vinyl Reclining Bucket Seats. Includes console and folding armrests	...			
Without AT5 or AS3 Seats	...	N.A.	364.00	364.00
With AT5 Center Seat without AS3 Center and Rear Seats. Includes full carpeting	...	N.A.	505.00	505.00
With AS3 Center and Rear Seats. Includes full carpeting	...	N.A.	555.00	555.00

(a) D & H Charges on vehicle and optional equipment include reimbursement to ordering Division for any tax that it has paid, incurred or agreed to pay thereon.
 ◊ State and local taxes not included.

C-K SUBURBAN

OPTIONS WHEN INSTALLED BY GENERAL MOTORS

Prices shown are effective with initial shipments of 1986 model motor vehicles

Description	Option Number	Factory D&H(a)	List Price	Mfr's Suggested Retail Price◇
Paints, Exterior: (See Interior and Exterior Color Selection Chart for ordering information).				
Solid	ZY1			NO ADDITIONAL CHARGE
Special Two-Tone.				
Without Z62 or YE9. Includes YG1 Custom Molding Package and wheel opening moldings	ZY3	N.A.	327.00	327.00
With Z62. Includes YG1 Custom Molding Package and wheel opening moldings	ZY3	N.A.	198.00	198.00
With YE9	ZY3	N.A.	170.00	170.00
Exterior Decor Package. Includes dual-tone side, rear decal striping and hood ornament.				
Without Z62 or YE9. Also includes YG1 Custom Package, wheel opening moldings and hood accent stripes.	ZY5	N.A.	485.00	485.00
With Z62. Also includes YG1 Custom Package, wheel opening moldings and hood accent stripes	ZY5	N.A.	356.00	356.00
With YE9	ZY5	N.A.	328.00	328.00
Emission Systems: Dealer Note - One of the following emission options must be specified. (See Power Teams Chart for availability and complete specifications)				
California Emission Requirements: Not available when B3J Diesel Equipment, LE9 5.0 Liter Engine, NA5 Standard or NA6 High Altitude Emissions are specified. Includes all testing, equipment and/or certification necessary for registration in the State of California				
Without LT9 5.7 Liter or LE8 7.4 Liter Engine	YF5	N.A.	235.00	235.00
With LT9 5.7 Liter or LE8 7.4 Liter Engine	YF5	N.A.	(-235.00)	(-235.00)
High Altitude Emission Equipment. Not available when NA5 Standard or YF5 California Emissions are specified				
Standard Emission Equipment. Not available when YF5 California or NA6 High Altitude Emissions are specified ..	NA6			NO ADDITIONAL CHARGE
	NA5			NO ADDITIONAL CHARGE
Engines: (See Power Teams Chart for availability and complete specifications)				
Gasoline.				
5.0 Liter (305 Cu. In.) 4 BBL V8. C1 Series only	LE9			NO ADDITIONAL CHARGE
5.7 Liter (350 Cu. In.) 4 BBL V8. Standard on K1 Series. C1 Series only	LS9			NO ADDITIONAL CHARGE
5.7 Liter (350 Cu. In.) 4 BBL V8. C-K2 Series only	LT9			NO ADDITIONAL CHARGE
7.4 Liter (454 Cu. In.) 4 BBL V8. C2 Series only. Available only when NA1 Power Steering and UA1 H.D. Battery are specified	LE8	N.A.	365.00	365.00
Diesel.				
6.2 Liter (379 Cu. In.) L.D. V8 Diesel. C-K1 Series only. Available only when B3J Diesel Equipment is specified. Not available when YF5 California Emission Requirements is specified	LH6			NO ADDITIONAL CHARGE
6.2 Liter (379 Cu. In.) H.D. V8 Diesel. C-K2 Series only. Available only when B3J Diesel Equipment is specified ..	LL4			NO ADDITIONAL CHARGE
Transmissions:				
4-Speed Manual. C2 or K1-2 Series only. Not available when LE8 7.4 Liter Engine or B3J Diesel Equipment is specified ..	MM4			NO ADDITIONAL CHARGE
4-Speed Automatic Overdrive. Standard on C1 Gasoline and Diesel Series and K1 Diesel Series.	MX0	N.A.	695.00	695.00
3-Speed Automatic. C-K2 Series only. Standard with B3J Diesel Equipment	MX1	N.A.	535.00	535.00
Axles, Rear: (See Power Teams Chart for option number selection, availability and complete specifications)				
Optional Ratio		N.A.	38.00	38.00
Locking Differential	G80	N.A.	238.00	238.00

(a) D & H Charges on vehicle and optional equipment include reimbursement to ordering Division for any tax that it has paid, incurred or agreed to pay thereon.
 ◇ State and local taxes not included.

C-K SUBURBAN

OPTIONS WHEN INSTALLED BY GENERAL MOTORS

Prices shown are effective with initial shipments of 1986 model motor vehicles

Description	Option Number	Factory D&H(a)	List Price	Mfr's Suggested Retail Price ◇
Tires: (See Tire Charts for Tire Availability)				
All rim sizes are 6.00" on C-K1 Series except when N67, N90 or PA6 wheels are specified.				
All rim sizes are 6.50" on C-K2 Series.				
TUBELESS				
P215/75R15 All Seasons Steel Belted Radial Ply Blackwall (Maximum Capacity 1583-lbs)				
K1 Series only. Not available when B3J Diesel Equipment is specified				
Front (Standard)	XCU		NO ADDITIONAL CHARGE	
Rear (Standard)	YCU		NO ADDITIONAL CHARGE	
Spare (Standard)	ZCU		NO ADDITIONAL CHARGE	
P215/75R15 All Seasons Steel Belted Radial Ply Whitewall. (Maximum Capacity 1583-lbs).				
Front	XCV	N.C.	28.00	28.00
Rear	YCV	N.C.	28.00	28.00
Spare	ZCV	N.C.	14.00	14.00
P235/75R15 All Seasons Steel Belted Radial Ply Blackwall (Maximum Capacity 1843-lbs)				
Front				
C1 Series only (Standard). Not available when B3J Diesel Equipment is specified				
	XFL		NO ADDITIONAL CHARGE	
K1 Series only				
Without B3J Diesel Equipment	XFL	N.C.	50.00	50.00
With B3J Diesel Equipment (Standard)	XFL		NO ADDITIONAL CHARGE	
Rear				
C1 Series only (Standard). Not available when B3J Diesel Equipment is specified				
	YFL		NO ADDITIONAL CHARGE	
K1 Series only				
Without B3J Diesel Equipment	YFL	N.C.	50.00	50.00
With B3J Diesel Equipment (Standard)	YFL		NO ADDITIONAL CHARGE	
Spare				
C1 Series only (Standard). Not available when B3J Diesel Equipment is specified				
	ZFL		NO ADDITIONAL CHARGE	
K1 Series only				
Without B3J Diesel Equipment	ZFL	N.C.	25.00	25.00
With B3J Diesel Equipment (Standard)	ZFL		NO ADDITIONAL CHARGE	
P235/75R15 On-Off Road Steel Belted Radial Ply Blackwall (Maximum Capacity 1843-lbs)				
Front, K1 Series only				
Without B3J Diesel Equipment	XES	N.C.	70.00	70.00
With B3J Diesel Equipment	XES	N.C.	20.00	20.00
Rear				
C1 Series only. Not available when B3J Diesel Equipment is specified				
	YES	N.C.	20.00	20.00
K1 Series only				
Without B3J Diesel Equipment	YES	N.C.	70.00	70.00
With B3J Diesel Equipment	YES	N.C.	20.00	20.00
Spare				
C1 Series only. Not available when B3J Diesel Equipment is specified				
	ZES	N.C.	10.00	10.00
K1 Series only				
Without B3J Diesel Equipment	ZES	N.C.	35.00	35.00
With B3J Diesel Equipment	ZES	N.C.	10.00	10.00

(a) D & H Charges on vehicle and optional equipment include reimbursement to ordering Division for any tax that it has paid, incurred or agreed to pay thereon.
 ◇ State and local taxes not included.

C-K SUBURBAN

OPTIONS WHEN INSTALLED BY GENERAL MOTORS

Prices shown are effective with initial shipments of 1986 model motor vehicles

Description	Option Number	Factory D&M(a)	List Price	Mfr's Suggested Retail Price◇
Tires: (Continued)				
<i>P235/75R15 All Seasons Steel Belted Radial Ply Whitewall</i> (Maximum Capacity 1843-lbs)				
Front				
C1 Series only. Not available when B3J Diesel Equipment is specified	XFM	N.C.	34.00	34.00
K1 Series only				
Without B3J Diesel Equipment	XFM	N.C.	84.00	84.00
With B3J Diesel Equipment	XFM	N.C.	34.00	34.00
Rear				
C1 Series only. Not available when B3J Diesel Equipment is specified	YFM	N.C.	34.00	34.00
K1 Series only				
Without B3J Diesel Equipment	YFM	N.C.	84.00	84.00
With B3J Diesel Equipment	YFM	N.C.	34.00	34.00
Spare				
C1 Series only. Not available when B3J Diesel Equipment is specified	ZFM	N.C.	17.00	17.00
K1 Series only				
Without B3J Diesel Equipment	ZFM	N.C.	42.00	42.00
With B3J Diesel Equipment	ZFM	N.C.	17.00	17.00
<i>P235/75R15 All Seasons Steel Belted Radial Ply Blackwall</i> (Maximum Capacity 1984-lbs). Standard on C1 Series when B3J Diesel Equipment is specified				
Front				
C1 Series only				
Without B3J Diesel Equipment	XHA	N.C.	18.00	18.00
With B3J Diesel Equipment	XHA	NO ADDITIONAL CHARGE		
K1 Series only				
Without B3J Diesel Equipment	XHA	N.C.	68.00	68.00
With B3J Diesel Equipment	XHA	N.C.	18.00	18.00
Rear				
C1 Series only				
Without B3J Diesel Equipment	YHA	N.C.	18.00	18.00
With B3J Diesel Equipment	YHA	NO ADDITIONAL CHARGE		
K1 Series only				
Without B3J Diesel Equipment	YHA	N.C.	68.00	68.00
With B3J Diesel Equipment	YHA	N.C.	18.00	18.00
Spare				
C1 Series only				
Without B3J Diesel Equipment	ZHA	N.C.	9.00	9.00
With B3J Diesel Equipment	ZHA	NO ADDITIONAL CHARGE		
K1 Series only				
Without B3J Diesel Equipment	ZHA	N.C.	34.00	34.00
With B3J Diesel Equipment	ZHA	N.C.	9.00	9.00
<i>P235/75R15 All Seasons Steel Belted Radial Ply Whitewall</i> (Maximum Capacity 1984-lbs)				
Front				
C1 Series only				
Without B3J Diesel Equipment	XHB	N.C.	54.00	54.00
With B3J Diesel Equipment	XHB	N.C.	36.00	36.00
K1 Series only				
Without B3J Diesel Equipment	XHB	N.C.	104.00	104.00
With B3J Diesel Equipment	XHB	N.C.	54.00	54.00
Rear				
C1 Series only				
Without B3J Diesel Equipment	YHB	N.C.	54.00	54.00
With B3J Diesel Equipment	YHB	N.C.	36.00	36.00
K1 Series only				
Without B3J Diesel Equipment	YHB	N.C.	104.00	104.00
With B3J Diesel Equipment	YHB	N.C.	54.00	54.00
Spare				
C1 Series only				
Without B3J Diesel Equipment	ZHB	N.C.	27.00	27.00
With B3J Diesel Equipment	ZHB	N.C.	18.00	18.00
K1 Series only				
Without B3J Diesel Equipment	ZHB	N.C.	52.00	52.00
With B3J Diesel Equipment	ZHB	N.C.	27.00	27.00

(a) D & H Charges on vehicle and optional equipment include reimbursement to ordering Division for any tax that it has paid, incurred or agreed to pay thereon.
◇ State and local taxes not included.

C-K SUBURBAN

OPTIONS WHEN INSTALLED BY GENERAL MOTORS

Prices shown are effective with initial shipments of 1986 model motor vehicles

Description	Option Number	Factory D&H(a)	List Price	Mfr's Suggested Retail Price◇
Tires: (Continued)				
<i>LT235/85R16D Highway Steel Belted Radial Ply Blackwall</i>				
<i>(Maximum Capacity 2623-lbs) C-K2 Series only.</i>				
Front. (Standard)	XYM	NO ADDITIONAL CHARGE		
<i>LT235/85R16E Highway Steel Belted Radial Ply Blackwall</i>				
<i>(Maximum Capacity 3042-lbs). C-K2 Series only.</i>				
Front	XYN	.24	32.00	32.24
Rear. (Standard)	YYN	NO ADDITIONAL CHARGE		
Spare	ZYN	1.00	341.00	342.00
<i>LT235/85R16E On-Off Road Steel Belted Radial Ply Blackwall</i>				
<i>(Maximum Capacity 3042-lbs.)</i>				
Front. K2 Series only	XYT	.76	86.00	86.76
Rear. C-K2 Series only	YYT	.52	54.00	54.52
Spare. C-K2 Series only	ZYT	1.26	368.00	369.26

OTHER OPTIONS

Air Cleaner, Pre-Cleaner	K46	N.A.	42.00	42.00
Air Conditioning: <i>All-Weather.</i> Not available when V10 Cold-Climate Package is specified. Includes extra cooling.				
<i>Front. Included when C69 Front and Rear Air Conditioning is specified. Recommended for front seat area cooling only.</i>				
<i>Without B3J Diesel Equipment or LE8 7.4 Liter Engine.</i>				
<i>Also includes K81 66-Amp Generator when C49 Defogger or C36 Rear Heater are not specified.</i>				
Without Z62 or YE9 Also includes BB5 Headliner ..	C60	N.A.	888.00	888.00
With Z62 or YE9	C60	N.A.	740.00	740.00
With LE8 7.4 Liter Engine. Includes K22 94-Amp Generator				
Without Z62 or YE9. Also includes BB5 Headliner ..	C60	N.A.	888.00	888.00
With Z62 or YE9	C60	N.A.	740.00	740.00
With B3J Diesel Equipment	C60	N.A.	678.00	678.00
<i>Front and Rear. Rear Interior Roof Mounted. Available only when YE9 or Z62 is specified. Rear system operates on recirculating air.</i>				
<i>Without B3J Diesel Equipment or LE8 7.4 Liter Engine.</i>				
<i>Also includes K81 66-Amp Generator when C49 Defogger or C36 Rear Heater are not specified</i>				
With LE8 7.4 Liter Engine. Includes K22 94-Amp Generator	C69	N.A.	1160.00	1160.00
With B3J Diesel Equipment	C69	N.A.	1160.00	1160.00
With B3J Diesel Equipment	C69	N.A.	1098.00	1098.00
Appearance, Deluxe Front: Included when YE9 is specified. Includes dark argent grille with bright trim and dual rectangular headlamps.				
	V22	N.A.	109.00	109.00
Batteries: 12-Volt. 515 Cold Cranking Amps Delco Freedom. Not available when B3J Diesel Equipment is specified.				
Auxiliary	TP2	N.A.	126.00	126.00
Heavy-Duty. Included when V10 Cold-Climate Package is specified	UA1	N.A.	53.00	53.00
Bumper Equipment:				
<i>Bumpers, Deluxe. Front and Rear. Not available when V31 Bumper Guards are specified. Includes front and rear bumpers and black resilient impact strips</i>				
	VE5	N.A.	49.00	49.00
<i>Guards, Chromed. Front Bumper</i>	V31	N.A.	41.00	41.00
Clock: <i>Quartz Electric</i> Not available when UM6 Radio is specified				
Without YE9. Includes Z53 Voltmeter, Temperature and Oil Pressure Gages	U35	N.A.	79.00	79.00
With YE9	U35	N.A.	39.00	39.00

(a) D & H Charges on vehicle and optional equipment include reimbursement to ordering Division for any tax that it has paid, incurred or agreed to pay thereon.
 ◇ State and local taxes not included.

C-K SUBURBAN

OPTIONS WHEN INSTALLED BY GENERAL MOTORS

Prices shown are effective with initial shipments of 1986 model motor vehicles

Description	Option Number	Factory D&H(a)	List Price	Mfr's Suggested Retail Price ◇
OTHER OPTIONS				
Cold-Climate Package: Not available when B3J Diesel Equipment, C60 Front or C69 Front and Rear Air Conditioning is specified. Includes special heater and defroster, K05 Engine Block Heater, anti-freeze protection to -32 degrees, and UA1 H.D. Battery.				
Without Z82 Trailing Special, C36 Rear Heater or C49 Defogger. Also includes K81 66-Amp Generator	V10	N.A.	188.00	188.00
With Z82 Trailing Special, C36 Rear Heater or C49 Defogger	V10	N.A.	126.00	126.00
Cooling System: Recommended for heavy-duty trailering. Engine Oil. Not available when B3J Diesel Equipment is specified. Included when Z82 Trailing Special is specified				
Radiator, Heavy-Duty. Not available when B3J Diesel Equipment, C60 Front or C69 Front and Rear Air Conditioning is specified. C-K2 Series also not available when MX0 or MX1 Automatic Transmission is specified . .	KC4	N.A.	120.00	120.00
Radiator and Transmission Oil, Heavy-Duty. Available only when MX0 or MX1 Automatic Transmission is specified. Not available when V01 H.D. Raditor is specified. Included when Z82 Trailing Special is specified.	V01	N.A.	53.00	53.00
	V02	N.A.	59.00	59.00
Defogger, Rear Window: Electric. Available only when A33 Power Tailgate Window is specified. Not available when AJ1 Deep Tinted Glass is specified.				
Without C60 Front or C69 Front and Rear Air Conditioning, LE8 7.4 Liter Engine, B3J Diesel Equipment or Z82 Trailing Special. Includes K81 66-Amp Generator	C49	N.A.	145.00	145.00
With C60 Front or C69 Front and Rear Air Conditioning, B3J Diesel Equipment or Z82 Trailing Special	C49	N.A.	83.00	83.00
With LE8 7.4 Liter Engine without C60 Front or C69 Front and Rear Air Conditioning. Includes K22 94-Amp Generator	C49	N.A.	145.00	145.00
Door Lock System, Power: Available only when B85 Headliner, B3J Diesel Equipment, Z62, YE9, C60 Front or C69 Front and Rear Air Conditioning is specified.				
Side Doors only. Included with ZQ2 Operating Convenience Package	AU3	N.A.	198.00	198.00
Rear Door. Available only when ZW9 Body is specified	AU6	N.A.	60.00	60.00
Floor Covering: Mats, Color-Keyed, Floor, Removable Available only when YE9 is specified				
Front only	B32	N.A.	15.00	15.00
Rear only. Available only when B32 Front Mats are specified	B33	N.A.	20.00	20.00
Gages: Voltmeter, Temperature and Oil Pressure. Included when YE9 or U35 Electric Clock is specified				
	Z53	N.A.	40.00	40.00
Generators:				
66-Amp Delcotron. Not available when C36 Rear Heater is specified with C49 Defogger. Included when Z82 Trailing Special, C60 Front or C69 Front and Rear Air Conditioning, B3J Diesel Equipment, V10 Cold-Climate Package, C36 Rear Heater or C49 Defogger is specified	K81	N.A.	62.00	62.00
94-Amp Delcotron. Included when LE8 7.4 Liter Engine and C60 Front, C69 Front and Rear Air Conditioning, C36 Rear Heater or C49 Defogger is specified	K22	N.A.	62.00	62.00
Glass:				
Deep Tinted. Not available when C49 Defogger is specified. Includes tinted glass on passenger and driver's side door. Also includes dark laminated glass on side windows and rear door	AJ1	N.A.	280.00	280.00
Deep Tinted with Light Tinted Rear Window. Not available when AJ1 Deep Tinted Glass is specified. Includes tinted glass on passenger, driver's side and rear doors. Also includes dark laminated glass on side windows	AA3	N.A.	240.00	240.00

(a) D & H Charges on vehicle and optional equipment include reimbursement to ordering Division for any tax that it has paid, incurred or agreed to pay thereon.
 ◇ State and local taxes not included.

C-K SUBURBAN

OPTIONS WHEN INSTALLED BY GENERAL MOTORS

Prices shown are effective with initial shipments of 1986 model motor vehicles

Description	Option Number	Factory D&H(a)	List Price	Mfr's Suggested Retail Price◇
OTHER OPTIONS				
Harness, Trailer Wiring: Heavy-Duty 7-Lead. Included when Z82 Trailering Special is specified	UY7	N.A.	44.00	44.00
Headlamps: Halogen Hi-Beam. Available only when V22 Deluxe Front Appearance Package or YE9 is specified	TT5	N.A.	17.00	17.00
Headlamp Warning Buzzer	T63	N.A.	11.00	11.00
Headliner, interior: Full Length. Included when YE9, Z62, B3J Diesel Equipment, C60 Front or C69 Front and Rear Air Conditioning is specified. Includes dome lamp	BB5	N.A.	148.00	148.00
Heaters:				
Engine Block. 600 Watts, 120 Volts. Not available when B3J Diesel Equipment is specified. Included when V10 Cold-Climate Package is specified	K05	N.A.	31.00	31.00
Rear. Located on right side, behind rear fender well.				
Without C60 Front or C69 Front and Rear Air Conditioning, LE8 7.4 Liter Engine, B3J Diesel Equipment, C49 Defogger or Z82 Trailering Special. Includes K81 66-Amp Generator	C36	N.A.	256.00	256.00
With C60 Front or C69 Front and Rear Air Conditioning, B3J Diesel Equipment, C49 Defogger or Z82 Trailering Special	C36	N.A.	194.00	194.00
With LE8 7.4 Liter Engine without C60 Front, C69 Front and Rear Air Conditioning or C49 Defogger. Includes K22 94-Amp Generator	C36	N.A.	256.00	256.00
Front, Heavy Duty. Available only when B3J Diesel Equipment is specified. Not available when C60 Front or C69 Front and Rear Air Conditioning is specified	C42	N.A.	43.00	43.00
Hubs, Automatic Locking: K1-2 Series only	X6Z	N.A.	40.00	40.00
Lamps: Roof Marker. Five. Not available when YF5 California Emissions is specified.	U01	N.A.	50.00	50.00
Lighter, Cigarette: Included when YE9 or Z62 is specified	U37	N.A.	30.00	30.00
Mirrors, Exterior: LH and RH.				
Below-Eye-Line Type. 9" x 6.5"				
Painted	D44	N.A.	50.00	50.00
Stainless Steel	D45	N.A.	83.00	83.00
Camper Type. 7.5" x 10.5". Stainless steel. Adjustable arm feature to provide field of vision for vehicles to 96" wide. Shipped loose for dealer installation				
	DF2	N.A.	94.00	94.00
Moldings:				
Body Side, Black. Bright with black insert. Not available when YE9, B85 Bright Body Side Molding or YG3 Deluxe Molding Package is specified. Included when YG1 Custom Molding Package, ZY3 Special Two-Tone Paint, ZY5 Exterior Decor Package or Z62 is specified. Includes lower side and rear moldings of black plastic with bright trim	B84	N.A.	115.00	115.00
Body Side, Bright. Not available when ZY3 Special Two-Tone Paint, ZY5 Exterior Decor Package, B84 Black Body Side Moldings or YG1 Custom Molding Package is specified. Included when YG3 Deluxe Molding Package or YE9 is specified. Includes bright plastic body side and rear lower moldings with black paint trim plus bright trim for front side marker lamps and taillights				
Without Z62	B85	N.A.	144.00	144.00
With Z62	B85	N.A.	15.00	15.00
Custom Package. Not available when B85 Bright Body Side Moldings, YE9 or YG3 Deluxe Molding Package is specified. Included when ZY3 Special Two-Tone Paint or ZY5 Exterior Decor Package is specified. Includes bright trim for front side marker lamps and taillights, B84 Black Body Side and wheel opening moldings.				
Without Z62	YG1	N.A.	157.00	157.00
With Z62	YG1	N.A.	29.00	29.00

(a) D & H Charges on vehicle and optional equipment include reimbursement to ordering Division for any tax that it has paid, incurred or agreed to pay thereon.

◇ State and local taxes not included.

C-K SUBURBAN

OPTIONS WHEN INSTALLED BY GENERAL MOTORS

Prices shown are effective with initial shipments of 1986 model motor vehicles

Description	Option Number	Factory D&H(a)	List Price	Mfr's Suggested Retail Price◇
OTHER OPTIONS				
Moldings: (Continued)				
<i>Deluxe Package.</i> Included when YE9 is specified. Includes B85 Bright Body Side Moldings, bright trim for front side marker lamps and taillights and wheel opening moldings.				
Without ZY3 Special Two-Tone Paint, Z62 or ZY5 Exterior Decor Package	YG3	N.A.	173.00	173.00
With ZY3 Special Two-Tone Paint or ZY5 Exterior Decor Package	YG3	N.A.	16.00	16.00
With Z62	YG3	N.A.	44.00	44.00
<i>Guards, Door Edge</i>	B93	N.A.	22.00	22.00
Operating Convenience Package: Available only when Z62, YE9, B3J Diesel Equipment, C60 Front or C69 Front and Rear Air Conditioning or B85 Interior Headliner is specified. Includes A31 Power Windows and AU3 Power Side Door Locks				
	ZQ2	N.A.	488.00	488.00
Preliminary Price Information	B3W	N.A.	N.A.	N.A.
Radio Equipment:				
<i>AM Radio</i>	U63	N.A.	112.00	112.00
<i>AM/FM Radio</i>	U69	N.A.	171.00	171.00
<i>AM/FM Stereo Radio</i>	U58	N.A.	198.00	198.00
<i>AM/FM Stereo Radio with Stereo Cassette Tape</i>	UN3	N.A.	298.00	298.00
<i>AM/FM Stereo Radio with Seek and Scan, Stereo Cassette Tape and Digital Clock.</i> Includes dual rear speakers	UM6	N.A.	419.00	419.00
<i>Windshield Antenna.</i> Included with Radio	U76	N.A.	32.00	32.00
Seats: Seat trim matches front seat whether standard or optional. Includes seat area floor covering, floor insulation and (3) seat belts. <i>Dealer Note</i> - One of the following seat options must be specified. (Added weight includes passenger weight allowance of 150-lbs per seating position. Refer to vehicle and option weight section of Data Book).				
<i>Center only.</i> Non-adjustable type with independent LH and RH folding sections	AT5	N.A.	377.00	377.00
<i>Center and Rear.</i> Includes non-adjustable center and quick release removable type rear seats, (3) additional seat belts plus LH and RH rear arm rests with ashtrays.				
C1 Series only. Available only when HA or HB P235/75R15 Tires are specified.				
Without B3J Diesel Equipment. Also includes F59 Stabilizer	AS3	N.A.	722.00	722.00
With B3J Diesel Equipment	AS3	N.A.	684.00	684.00
C-K2 or K1 Series only. K1 Series available only when HA or HB P235/75R15 Tires are specified				
	AS3	N.A.	684.00	684.00
<i>Optional Seat Not Desired</i>	YG4	NO ADDITIONAL CHARGE		
Shield, Fuel Tank:				
C1-2 Series only.				
Without NE2 Fuel Tank	NY1	N.A.	49.00	49.00
With NE2 Fuel Tank	NY1	N.A.	123.00	123.00
K1-2 Series only. Includes transfer case skid plate.				
Without NE2 Fuel Tank	NY1	N.A.	90.00	90.00
With NE2 Fuel Tank	NY1	N.A.	164.00	164.00
Shock Absorbers: <i>Front and Rear, Heavy-Duty.</i> C1 Series only. Standard on C-K2 Series. Included when Z82 Trailering Special is specified				
	F51	N.A.	34.00	34.00
Shocks, Front Quad: K1-2 Series only. Includes dual left and right hand shock absorbers on front, heavy-duty shock absorbers on rear and a front axle nose bumper to limit axle windup.				
K1 Series only	Z75	N.A.	128.00	128.00
K2 Series only	Z75	N.A.	94.00	94.00
Speed Control, Electronic: Not available when MM4 4-Speed Transmission is specified				
	K34	N.A.	195.00	195.00

(a) D & H Charges on vehicle and optional equipment include reimbursement to ordering Division for any tax that it has paid, incurred or agreed to pay thereon.
◇ State and local taxes not included.

C-K SUBURBAN

OPTIONS WHEN INSTALLED BY GENERAL MOTORS

Prices shown are effective with initial shipments of 1986 model motor vehicles

Description	Option Number	Factory D&H(a)	List Price	Mfr's Suggested Retail Price◇
OTHER OPTIONS				
Springs: Front, Heavy-Duty. Capacity 2250-lb each.				
K1 Series only. Recommended for snowplow type usage only.				
Without Z75 Front Quad Shock Absorbers. Includes H.D. front and rear shock absorbers	F60	N.A.	92.00	92.00
With Z75 Front Quad Shock Absorbers	F60	N.A.	59.00	59.00
K2 Series only	F80	N.A.	59.00	59.00
Stabilizers:				
Front. 1" diameter. C1 Series only. Included when AS3 Seats or B3J Diesel Equipment is specified	F59	N.A.	38.00	38.00
Front, Heavy-Duty. 1.25" diameter. C2 Series only. Standard on K1-2 Series	F58	N.A.	17.00	17.00
Steering:				
Power. Standard on K1-2 Series. Included when Z82 Trailing Special or B3J Diesel Equipment is specified ..	N41	N.A.	260.00	260.00
Power, Not Desired. C1-2 Series only. Not available when Z82 Trailing Special or B3J Diesel Equipment is specified ..	N51	NO ADDITIONAL CHARGE		
Steering Wheel: Comfortilt	N33	N.A.	115.00	115.00
Tanks, Fuel: Replaces production fuel tank.				
Approximately 31-Gallon Capacity for Gasoline and 32-Gallon Capacity for Diesel	NK7	N.A.	43.00	43.00
Approximately 40-Gallon Capacity for Gasoline and 41-Gallon Capacity for Diesel	NE2	N.A.	99.00	99.00
Towing Device: Two front towing hooks.	V78	N.A.	36.00	36.00
Trailer Hitch:				
Deadweight Type. Not available when Z82 Trailing Special is specified	VR2	N.A.	58.00	58.00
Weight Distributing Platform Type. Not available when VR2 Deadweight Type Trailer Hitch is specified. Included when Z82 Trailing Special is specified	VR4	N.A.	155.00	155.00
Trailing Special Equipment: Includes VR4 Weight Distributing Hitch Platform, UY7 Wiring Harness and V02 H.D. Radiator Transmission Oil Cooler. (See Trailing Guide for GCW Ratings with available power team combinations.)				
C1 Series only. Available only when 3.73 or 3.12 rear axle ratio is specified. With B3J Diesel Equipment not available when YF5 California Emissions are specified. Also includes F51 H.D. Shock Absorbers.				
Without B3J Diesel Equipment. Available only when LS9 5.7 Liter Engine is specified. Also includes KC4 Engine Oil Cooler and N41 Power Steering.				
Without C60 Front or C69 Front and Rear Air Conditioning, C36 Rear Heater or C49 Defogger. Also available only when V01 H.D. Radiator is specified. Also includes K81 66-amp generator	Z82	N.A.	734.00	734.00
With C60 Front or C69 Front and Rear Air Conditioning, C49 Defogger or C36 Rear Heater	Z82	N.A.	672.00	672.00
With B3J Diesel Equipment	Z82	N.A.	258.00	258.00
C2 Series only. Available only when MX0 or MX1 Automatic Transmission is specified.				
Without B3J Diesel Equipment. Also includes N41 Power Steering and KC4 Engine Oil Cooler.				
Without C60 Front or C69 Front and Rear Air Conditioning, LE8 7.4 Liter Engine, C36 Rear Heater or C49 Defogger. Also includes K81 66-Amp Generator	Z82	N.A.	700.00	700.00
With LE8 7.4 Liter Engine. Includes K22 94-Amp Generator	Z82	N.A.	700.00	700.00
With C60 Front or C69 Front and Rear Air Conditioning, C36 Rear Heater or C49 Defogger	Z82	N.A.	638.00	638.00
With B3J Diesel Equipment	Z82	N.A.	258.00	258.00

(a) D & H Charges on vehicle and optional equipment include reimbursement to ordering Division for any tax that it has paid, incurred or agreed to pay thereon.
 ◇ State and local taxes not included.

NOTES

C/K SUBURBAN

**CAB & BODY FEATURES
CAB DIMENSIONS
SEATING ARRANGEMENTS
COLOR & TRIM CHARTS
TWO-TONES**

C/K SUBURBAN

CUSTOM DELUXE/SIERRA FEATURES—STANDARD MODEL

The Custom Deluxe/Sierra standard models include the following items as standard equipment



EXTERIOR

- **Bumpers:** Front and rear; chromed
- **Color:** See Interior and Exterior Color Selection Chart
- **Doors:** Four side doors, two LH and two RH; two rear panel doors (optional endgate with drop-glass available)
- **Glass:** Tinted; all windows; includes shade band on upper windshield
- **Grille and Headlamp Bezels:** Molded plastic; painted argent; integral Chevrolet emblem/GMC letters at center of grille
- **Horn:** Single, electric, low-note
- **Hub Caps:** Bright metal with black trim
- **Keys:** Two-key system with separate keys for ignition switch and door locks
- **Lights:**
 - Backup lamps: Two rear (integral with taillamps)
 - Combination parking/direction/hazard: Two front
 - Combination tail/stop/direction/hazard: Two rear
 - Headlamps: Two, rectangular
- **License plate lamp:** Single rear
- **Side marker lamps with reflectors:** Two front; two rear (integral with taillamps)
- **Mirrors:** RH and LH fixed arm with adjustable 5-7/16" wide x 4" high head; chrome finish
- **Moldings:** Bright; drip moldings over side and rear doors; headlamp and grille outline moldings
- **Nameplates:** Bright "Custom Deluxe/Sierra" nameplates, with series designation, on front fenders near doors; bright "Suburban" nameplate on RH rear door
- **Tools:** Mechanical jack and wheel wrench
- **Wheels:** Painted white
- **Windshield Wipers and Washers:** Electric, 2-speed wipers with black finish on exposed metal portions; wet-arm demand-type washer system



C/K SUBURBAN

CUSTOM DELUXE/SIERRA FEATURES—STANDARD MODEL

The Custom Deluxe/Sierra standard models include the following items as standard equipment

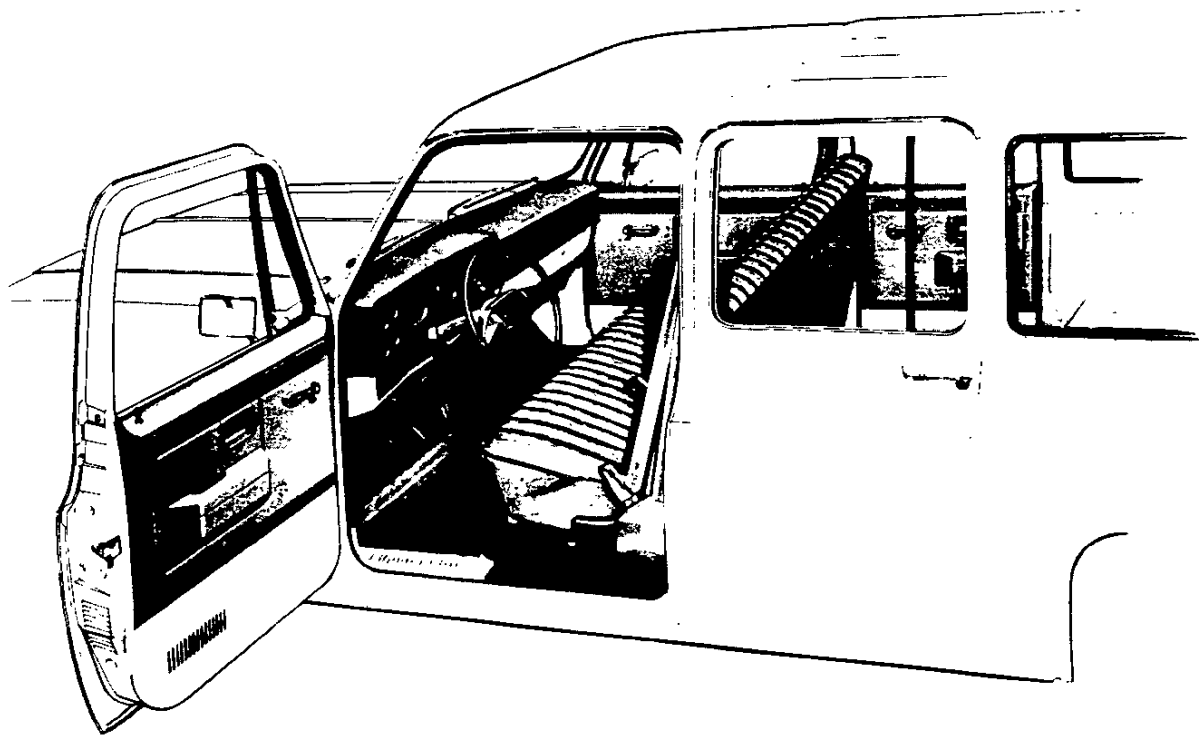

INTERIOR

- **Armrests:** RH and LH padded; integral with side door trim panels
- **Ashtrays:** In middle of instrument panel and in rear side door trim panels
- **Coat Hooks:** Over RH and LH rear side door openings
- **Colors:**
 - Painted areas: Same as exterior primary color choice
 - Interior trim: Coordinated with seat trim color choices
- **Floor Covering:** Embossed black rubber mats over entire floor area; color-keyed carpeting on rear face of seat backs on center seats (when optional center seats are ordered)
- **Heater and Defogger:** Deluxe-air
- **Hood Lock Release:** Handle located on LH side under instrument panel
- **Instrument Cluster Bezel:** Black crackle finish with bright trim
- **Instruments:**
 - Gages: Speedometer, odometer and fuel
 - Switches: Main, for control of exterior lights, instrument cluster lights, and interior lights; multi-function switch on steering column for direction signals by moving lever up or down (includes lane change position), headlamp beams by pulling lever toward driver, windshield wiper by turning band marked "WIPER" toward or away from driver, and windshield washer by pushing in the lever knob; ignition with key-in warning buzzer; hazard warning; heater fan
 - Warning lights: Generator, oil pressure, engine temperature, seat belt, service-parking brake, direction/hazard signal, high beam
- **Instrument Panel Control Knobs:** Soft black plastic (except heater and wiper-washer controls) with white graphic identification
- **Instrument Panel Pad:** Color-keyed, energy-absorbing foam type with grained vinyl skin; has black crackle finish applique on RH side with bright, black, and silver trim and bright "Custom Deluxe/Sierra" nameplate
- **Insulation and Sound Deadening Material:** Dash (firewall), under floor mats and under front seat at center (includes extra-thick insulation in center seat area when optional seat is ordered)
- **Lights:** Instrument cluster and cab interior lights
- **Mirror, Rearview:** 10" prismatic with soft vinyl rim
- **Seat:** Full-width, full-depth foam bench-type front seat only with embossed grained all-vinyl trim. See Interior and Exterior Color Selection Chart for color and trim availability
- **Seat Belts:** Front only; non-detachable combination lap and shoulder belts for outboard positions with automatic-locking retractors on lap belts; emergency-locking retractors on shoulder belts, and switch in driver's lap belt retractor for buzzer warning system; lap belt with manual adjustment for center position. All seat belts are color-keyed with pushbutton type buckles
- **Sill Plates:** Door-opening protection and floor mat retention; bright metal; partial for front side doors, full-length for rear side doors, and full-width front and rear for rear compartment platform
- **Spare Tire Carrier:** LH rear side
- **Steering Wheel and Column:** 16" black, soft plastic wheel with 2 spokes; black energy-absorbing steering column with anti-theft locking feature
- **Stowage Box:** In RH side of instrument panel; door has bright turn-type latch release
- **Sunshades:** RH and LH padded; color-keyed
- **Trim Panels:** Color-keyed, embossed molded plastic on side doors with integral armrests; painted steel panels on rear quarter areas

C/K SUBURBAN

SCOTTSDALE/HIGH SIERRA MODEL OPTION—RPO Z62

This option includes all Custom Deluxe/Sierra standard model items plus the additions or substitutions listed below

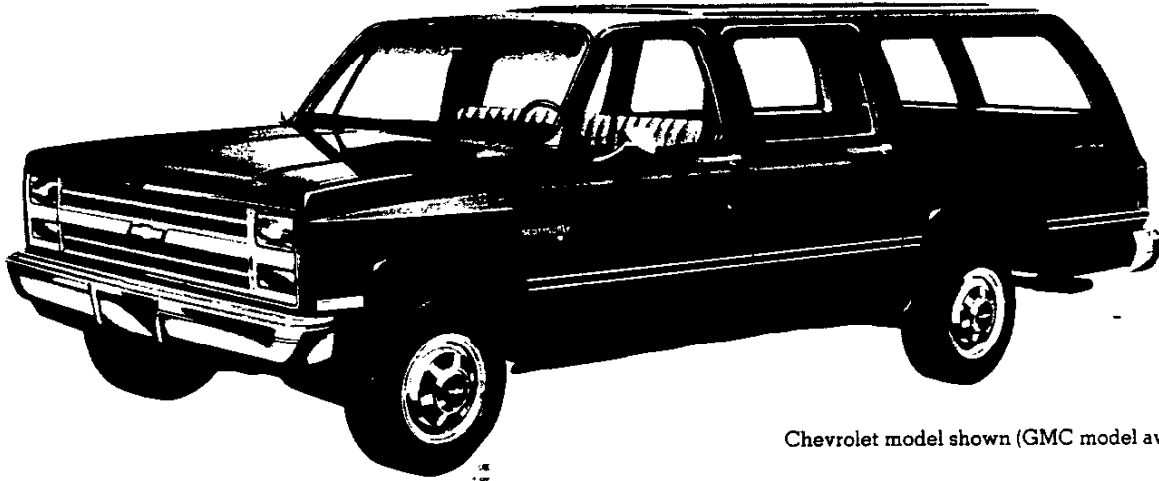

Chevrolet model shown (GMC model available)

• Bright Appearance Items:

- "Scottsdale/High Sierra" nameplates, with series designation, on front fenders
- Body side and rear molding trim
- Chevrolet emblem/GMC letters at grille center
- Dome lamp trim

EXTERIOR

- Side marker lamp and taillamp trim
- Windshield reveal moldings
- Rear side window trim
- **Horn:** Additional, electric, high-note
- **Moldings:** Black plastic body side and rear moldings with bright trim

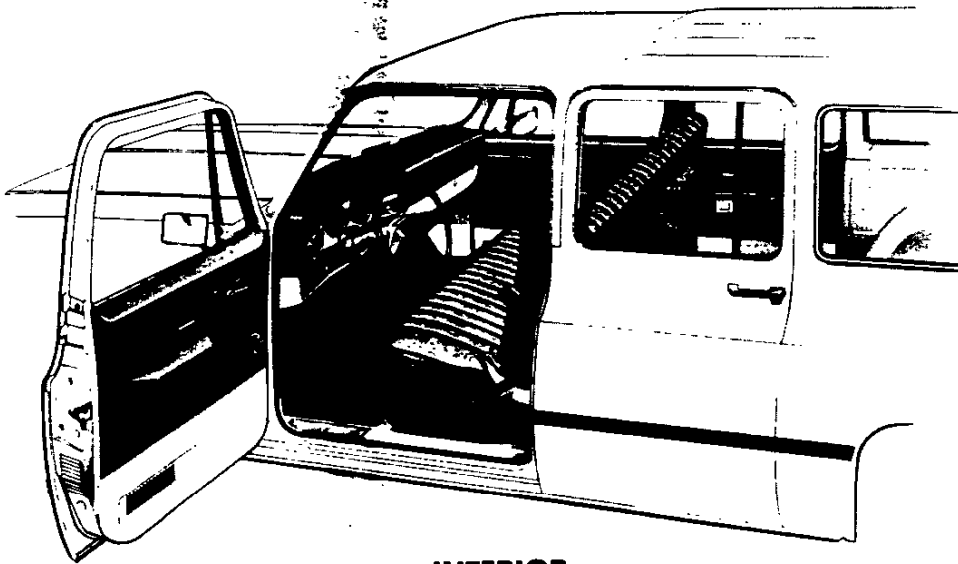

INTERIOR

• Bright Appearance Items:

- "Scottsdale/High Sierra" nameplate on instrument panel pad
- Trim on instrument cluster bezel and instrument panel pad applique
- **Cigar Lighter:** With fiber optic illuminated ashtray
- **Dome Lamps:** Two; one front, one rear
- **Dome and Interior Lamp Switches:** Front and rear side door actuated (dome and interior lamps also may be activated by main light switch)
- **Floor Covering:** Color-keyed rubber mat in front seat area (also in center and rear seat areas when optional center seat is ordered)
- **Headliner:** Full-length, color-keyed, perforated molded plastic

with fiberglass blanket backing; includes matching retainer moldings

- **Insulation:** Under cowl panel and on back of headliner
- **Pillar Trim Panels:** Color-keyed molded plastic on windshield pillars and center door pillars
- **Seats:** Embossed grained all-vinyl trim standard. Also available at extra cost: 1) textured velour cloth/vinyl trim; or 2) all-vinyl pigskin grained trim. See Interior and Exterior Color Selection Chart for color and trim availability
- **Sill Plates:** Full-length bright metal for front side doors
- **Spare Tire Cover:** Color-keyed carpet
- **Sunshades:** Mystic colored to match headliner

C/K SUBURBAN SILVERADO/SIERRA CLASSIC MODEL OPTION—RPO YE9

This option includes all items in the Scottsdale model option plus the additions or substitutions listed below



GMC model shown (Chevrolet model available)

EXTERIOR

• **Bright Appearance Items:**

- "Silverado/Sierra Classic" nameplates, with series designation, on front fenders
- Chrome-trimmed grille and headlamp bezels (Chevrolet models only)
- Body side and rear door (or tailgate) moldings with black paint trim

Bright wheel opening lip moldings

- **Body-to-Fender Insulators**
- **Grille and Headlamp Bezel Paint:** Dark argent (Chevrolet); argent/dark argent (GMC)
- **Hood Insulator**
- **Special Headlamps:** Rectangular; dual RH and LH

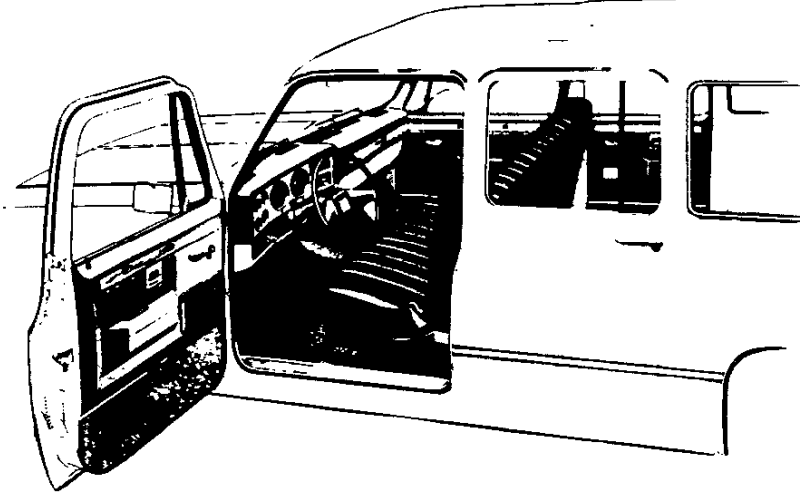

INTERIOR

• **Bright Appearance Items:**

- "Silverado/Sierra Classic" nameplate on instrument panel pad
- MM4 four-speed transmission shift lever (C1-2 models only)
- Trim on side door trim panels, and on horn button
- **Cowl Panel Trim:** Color-keyed molded plastic on entire surface of cowl side panels
- **Floor Covering:** Color-keyed carpeting; front seat area (also in center and rear seat areas and on wheelhousings)
- **Garnish Moldings:** Color-keyed molded plastic for body sides (in side rear window areas), lower rear lock pillars, and upper rear doors
- **Headliner:** Full length, color-keyed, foam backed cloth; includes matching retainer moldings
- **Instrument Cluster:** Voltmeter, engine temperature gage, and oil pressure gage replace warning lights; includes pewter-toned brush-finished bezel
- **Instrument Panel Pad Applique:** Pewter-toned brushed finish with bright, black, and silver trim
- **Insulation:** Extra-thick front compartment floor insulators, including full-width insulator under front seat (also in center and

rear seat areas when optional center seat is ordered), on back of headliner, and on body side trim panels

- **Seats:** Choice of: 1) all-vinyl pigskin grained trim; or 2) textured velour cloth/vinyl trim. Also available at extra cost: High back bucket seats are available in Custom Vinyl or Custom Cloth (includes console). See Interior and Exterior Color Selection Chart for color and trim availability
- **Trim Panels:** Color-keyed molded plastic door trim panels (with door closing assist strap and vinyl stowage pockets; on front door units only); includes pewter-toned brush-finished upper decorative inserts having bright, black, and silver borders, cloth inserts in armrest area plus carpeting on lower portions. Vinyl-covered color-keyed molded plastic body side trim panels (in rear quarter areas) with carpet trim. Vinyl-covered color-keyed hardboard lower rear door trim panels with carpet trim. (Color-keyed molded plastic tailgate trim panel with carpet trim for models with optional tailgate)
- **Steering Wheel:** Bright trim on horn button
- **Visor Mirror:** On RH sun visor

C/K SUBURBAN REAR DOOR TYPES

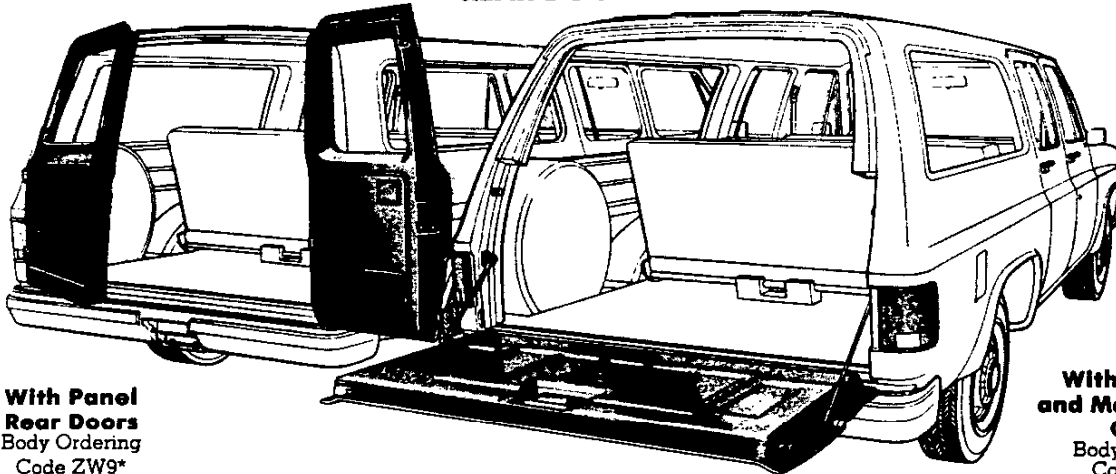

**With Panel
Rear Doors**
Body Ordering
Code ZW9*

**With Tailgate
and Manual Drop
Glass**
Body Ordering
Code E55*

Suburban models have 4 side doors, two front and two rear. Front side doors are equipped with drop-glass and ventipane assemblies; the rear side doors have a drop-glass in the forward portion and fixed glass in the rear portion. The rear quarter windows have fixed glass.

All Suburbans ordered with Body Ordering Code ZW9 have panel-type rear doors incorporating fixed glass, positive fork-cam latches, and an outside key lock. A 2-position, strap-type check on each door permits either a 118- or 162-degree door opening, depending on how the retaining pin is positioned; full door opening of 172-degrees is obtained by removing the retaining pin.

Suburbans ordered with Body Ordering Code E55 have a tailgate with a manually-controlled curved drop glass. Operation of the window is through an articulated crank-type regulator handle on the tailgate outer panel; a key lock cylinder is concealed in the regulator handle, and must be unlocked before the window can be lowered. After the window is lowered, the tailgate can be lowered by moving the release handle at the upper center of the tailgate inner panel. When the tailgate is open, it is supported by reel-type cables. Embossments on the tailgate inner panel facilitate loading of large objects. An optional electric tailgate window is available by ordering RPO A33.

*Both models shown with optional folding center and removable rear seats

CUSTOM OPTIONS

Chromed Bumpers with Rub Strips (RPO VE5)



Chromed bumpers with rub strips are available optionally on all Suburban models.

Custom Trim Moldings (RPO B84, B96, YG1)

Body side and rear trim moldings (RPO B84) are black plastic with bright trim and are available for standard Suburban models. They are included in the Custom Molding Package (RPO YG1) for standard and Scottsdale/High Sierra models which also includes bright wheel opening moldings with black paint trim (RPO B96) and bright trim for front side marker lamps and taillamps.

(RPO B85, B96, YG3)

Bright plastic body side and rear moldings with black paint trim (RPO B85) are available for standard and Scottsdale/High Sierra Suburban models. They are included in the Deluxe Molding Package (RPO YG3) which also includes the wheel opening moldings (RPO B96) and other bright lamp trim items described above for RPO YG1.

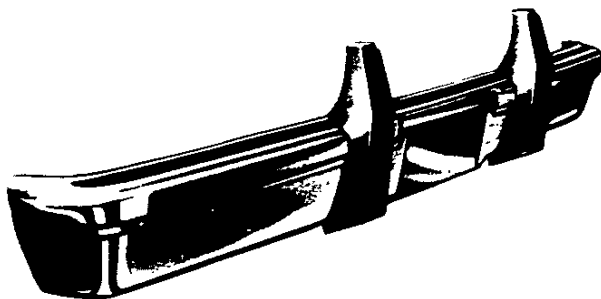

Chromed Front Bumper Guards (RPO V31)

Chromed front bumper guards with rub strips are available optionally on Suburban models. Not available when chromed bumpers with rub strips are ordered.



Wheel Covers

Stainless steel wheel covers are available on all Suburban models. The front units for K10/1500-20/2500 models with 4WD have a cut-out at the center to clear the axle hubs.

C/K SUBURBAN DIMENSIONS

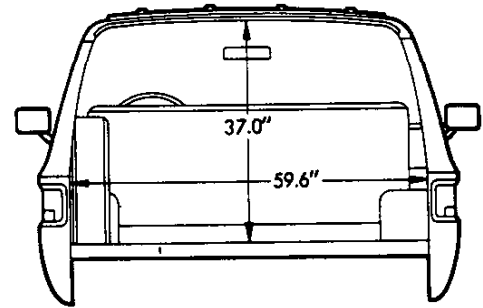
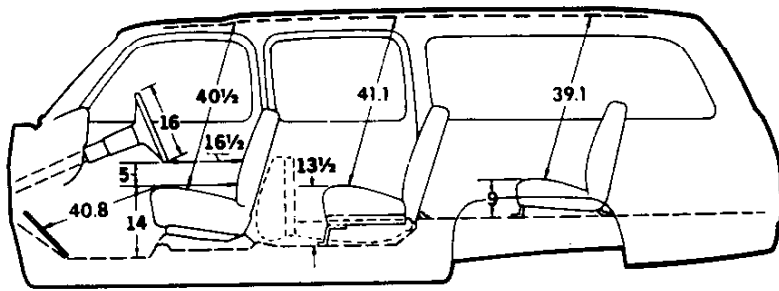

GLASS AREA (Sq. in.)

Windshield 1421
 Front side door, including
 ventipane (each side) 470
 Rear side door (each side) 488

Side rear window (each side) . . . 1074
 Rear:
 ZW9 panel doors (total) 654
 E55 tailgate 1041

SEATING ARRANGEMENTS

Front Seat
 Standard full-depth foam front seat

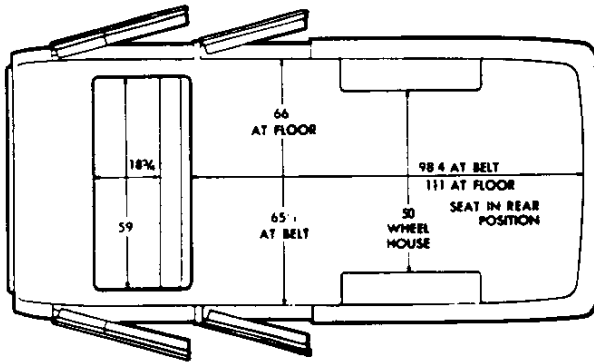

Front and Folding Center Seats
 Standard front and RPO AT5 folding center seats

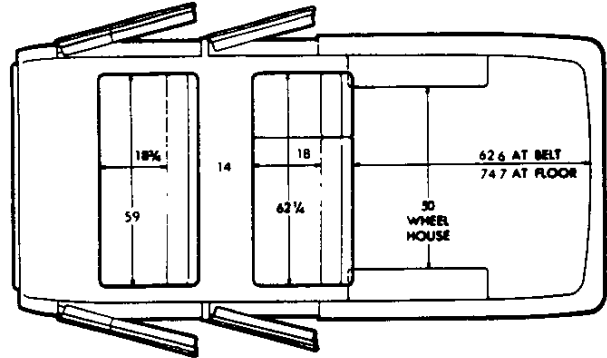

Front and Folding Center Seats
 Standard front and RPO AT5 folding center seats
 (Center seats shown in folded position)

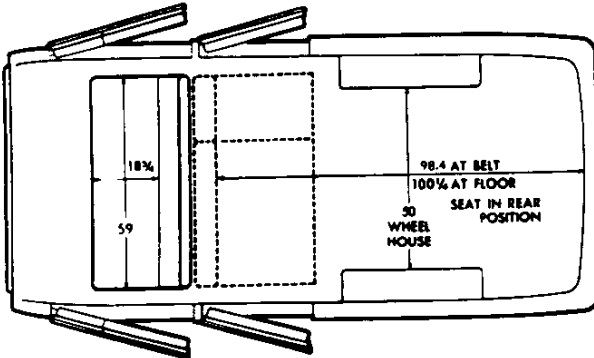

Front, Folding Center and Rear Removable Seats
 Standard front, RPO AT5 folding center and
 RPO AS3 removable rear seats

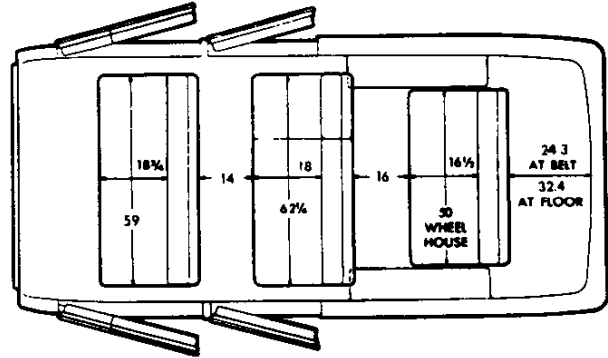

C/K SUBURBAN

INTERIOR AND EXTERIOR COLOR AVAILABILITY CHART

Please Note: Below are the interior trim color and exterior paint combinations recommended by Chevrolet/GMC. The only available color code 1/color code 2 exterior color combinations are those shown in the chart below; however, any available interior trim color may be ordered with one of these exterior color combinations if that particular combination is desired by the customer.

INTERIOR COLORS		Decor	Blue	Burgundy	Saddle Tan	Slate Gray
CUSTOM DELUXE/SIERRA Vinyl Bench Seat		Std.	VDD1		VSS1	
SCOTTSDALE/HIGH SIERRA Vinyl Bench Seat		Z62	VDD1		VSS1	
Custom Vinyl Bench Seat			XDD1		XSS1	
Custom Cloth Bench Seat			LDD1		LSS1	
SILVERADO/SIERRA CLASSIC Custom Vinyl Bench Seat		YE9	XDD1	XEE1	XSS1	
Custom Cloth Bench Seat			LDD1	LEE1	LSS1	LTT1
Custom Vinyl Reclining Bucket			XDD6		XSS6	
Custom Cloth Reclining Bucket			LDD6		LSS6	LTT6
EXTERIOR COLORS w/ZY1 or ZY3 PAINT	Color Code 1	Color Code 2	RECOMMENDED INTERIOR TRIM COLOR			
BLACK, MIDNIGHT	19	19		X	X	X
Gray, Steel (Metallic)	19	90				X
Tan, Doeskin	19	61			X	
White, Frost	19	12				X
BLUE, LIGHT (Metallic)	21	21	X			X
Blue, Midnight	21	29	X			
Gray, Steel (Metallic)	21	90	X			X
White, Frost	21	12	X			
BLUE, MIDNIGHT	29	29	X			X
Blue, Light (Metallic)	29	21	X			
Gray, Steel (Metallic)	29	90	X			X
White, Frost	29	12	X			
BRONZE, INDIAN (Metallic)	66	66			X	
Tan, Doeskin	66	61			X	
White, Frost	66	12			X	
COPPER, CANYON (Metallic)	55	55			X	
Black, Midnight	55	19			X	
Tan, Doeskin	55	61			X	
White, Frost	55	12			X	
GOLD, NEVADA (Metallic)	67	67			X	
Black, Midnight	67	19			X	
Tan, Doeskin	67	61			X	
White, Frost	67	12			X	
GRAY, STEEL (Metallic)	90	90	X	X		X
Black, Midnight	90	19				X
Blue, Light (Metallic)	90	21	X			
Blue, Midnight	90	29	X			
Red, Apple	90	72				X
White, Frost	90	12				X
RED, APPLE	72	72		X	X	
Gray, Steel (Metallic)	72	90		X		
Tan, Doeskin	72	61		X	X	
White, Frost	72	12		X		
TAN, DOESKIN	61	61			X	
Black, Midnight	61	19			X	
White, Frost	61	12			X	
WHITE, FROST	12	12	X	X	X	X
Black, Midnight	12	19		X		X
Blue, Light (Metallic)	12	21	X			
Blue, Midnight	12	29	X			
Red, Apple	12	72		X		
Gray, Steel (Metallic)	12	90				X
Tan, Doeskin	12	61			X	
w/ZY5 PAINT (Interior and Exterior Combinations Shown are the Only Combinations Available)						
BLACK, MIDNIGHT/Red, Apple	19	72		X		Vermillion/Black
BLACK, MIDNIGHT/Gray, Steel (Met)	19	90				Vermillion/Black
BLACK, MIDNIGHT/Tan, Doeskin	19	61			X	Vermillion/Black
BLACK, MIDNIGHT/White, Frost	19	12				Vermillion/Black
BLUE, LIGHT (Met)/Blue, Midnight	21	29	X			Light Blue/Dark Blue
BLUE, LIGHT (Met)/Gray, Steel (Met)	21	90	X			Dark Blue/Light Slate
BLUE, LIGHT (Met)/White, Frost	21	12	X			Dark Blue/White
BLUE, MIDNIGHT/Blue, Light (Met)	29	21	X			Light Blue/Dark Blue
BLUE, MIDNIGHT/Gray, Steel (Met)	29	90	X			Vermillion/Light Slate
BRONZE, INDIAN (Met)/Tan, Doeskin	66	61			X	Almond/Dark Brown
BRONZE, INDIAN (Met)/White, Frost	66	12			X	Almond/Dark Brown
COPPER, CANYON (Met)/Tan, Doeskin	55	61			X	Dark Brown/Almond
COPPER, CANYON (Met)/White, Frost	55	12			X	Almond/Dark Brown
RED, APPLE/Black, Midnight	72	19		X		Vermillion/Black
RED, APPLE/Gray, Steel (Metallic)	72	90		X		Vermillion/Dark Carmine
RED, APPLE/Tan, Doeskin	72	61		X	X	Vermillion/Black
RED, APPLE/White, Frost	72	12		X		Vermillion/Black
GRAY, STEEL (Met)/Black, Midnight	90	19				Vermillion/Black
GRAY, STEEL (Met)/Blue, Light (Met)	90	21	X			Dark Blue/Light Blue
GRAY, STEEL (Met)/Blue, Midnight	90	29	X			Light Blue/Dark Blue
GRAY, STEEL (Met)/Red, Apple	90	72				Vermillion/Black
TAN, DOESKIN/Black, Midnight	61	19			X	Vermillion/Dark Carmine
TAN, DOESKIN/Red, Apple	61	72			X	Vermillion/Black

C/K SUBURBAN

SOLID AND TWO-TONE* EXTERIOR COLOR COMBINATIONS

The application of paint for solid and two-tone exterior color combinations is shown below.

Solid color paint (ZY1) is standard on all models. All painted areas of the body and front end sheet metal are the same color.

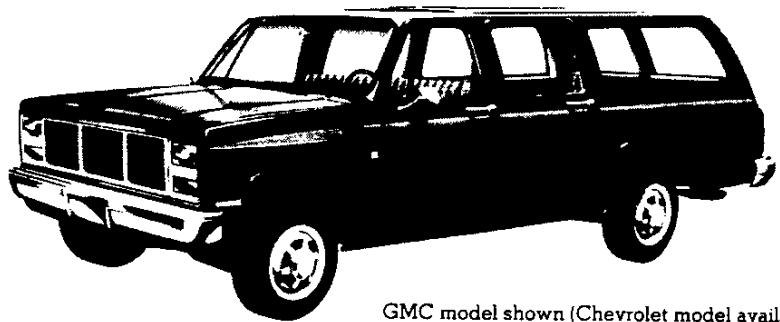

GMC model shown (Chevrolet model available)



Chevrolet model shown (GMC model available)

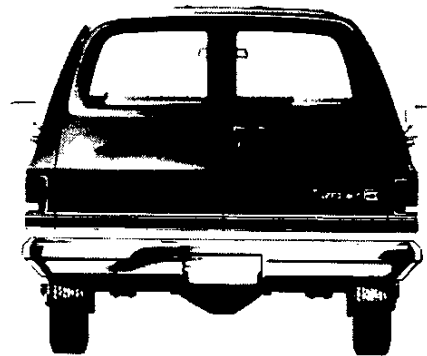

Special two-tone (ZY3) paint colors include the YG1 molding package consisting of black vinyl body side and rear moldings with bright trim, bright wheel opening moldings, and bright trim for front side marker lights and tail lights (except with the YG3 molding package or the Silverado/

Sierra Classic Model Option where bright body side and rear moldings with black paint trim are substituted). Color code 1 is applied to the areas above the moldings (including the roof). Color code 2 is applied to the areas below the moldings.



GMC model shown (Chevrolet model available)

Exterior Decor Package (ZY5) paint colors and trim are available (see Interior and Exterior Color Availability Chart). The package includes the moldings described under Special Two-Tone. In addition, it includes dual-tone body side and rear tape decal striping keyed to the exterior body color. This striping is applied to the front fenders, side doors and body sides and rear a few inches above the styling crease line. The areas above the striping and below the molding are painted color code 1. Color code 2 is used between the striping and the molding. A bright spring-loaded, stand-up type hood ornament is included on gasoline engine models.

*Optional at extra cost.

NOTES